

**CANARE®**



**PRODUCT CATALOG**  
**International edition 23A**



# Canare,

offering value-added products to meet your needs for today and tomorrow.



Canare Building in Nagoya

## Five-point Product Development Goal

- 1 Responsive**  
Fulfilling the needs of the industry through custom solutions.
- 2 Unique**  
Incorporating valuable features not offered by competitors.
- 3 Cutting-edge**  
Devoted to meeting the requirements for emerging technologies.
- 4 Enduring**  
Concentrated on products with long-term value.
- 5 Global**  
Focused on niche markets as well as universal products.

## Corporate Profile

- Name: Canare Electric Co., Ltd.
- Incorporated: February 1974 (commenced operation 1970)
- Capital: 1.04 billion yen
- Activities: Manufacture and sale of audio-video cables, connectors, assemblies, converters and related products for professional audio and video industry.

## Company Locations

Japan Headquarters (Overseas Department)  
WN Bldg., 2-4-1 Shin-Yokohama, Kouhoku-ku, Yokohama-shi,  
Kanagawa, 222-0033 Japan

Phone: +81-45-470-5674 Fax: +81-45-470-5676

- Sales office in Japan: Yokohama, Nagoya (Sales and Warehouse), Osaka, and Fukuoka

## Subsidiary Companies

- Canare Corporation of America [www.canare.com](http://www.canare.com)
- Canare Corporation of Korea [www.canare.co.kr](http://www.canare.co.kr)
- Canare Corporation of Taiwan [www.canare.com.tw](http://www.canare.com.tw)
- Canare Electric Corporation of Tianjin [www.canare.com.cn](http://www.canare.com.cn)
- Canare Singapore Private Ltd. [www.canare.com.sg](http://www.canare.com.sg)
- Canare Electric India Private Ltd. [www.canare.in](http://www.canare.in)
- Canare Electric (Shanghai) Co., Ltd.
- Canare Harness Co., Ltd (Japan)
- Canare System Works Co., Ltd (Japan)
- Canare Tech Corporation (Japan)

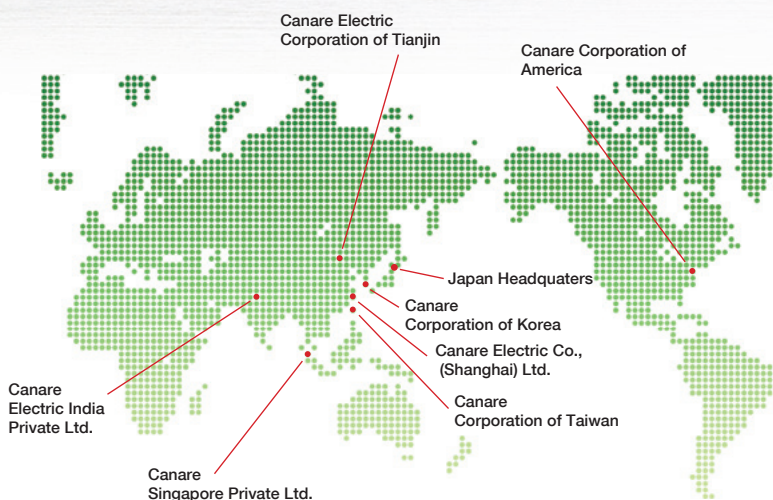



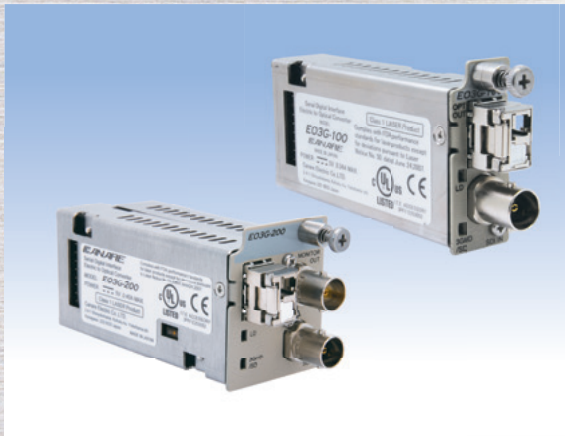

3G-SDI EO Converters

75Ω Active BNC Receptacles

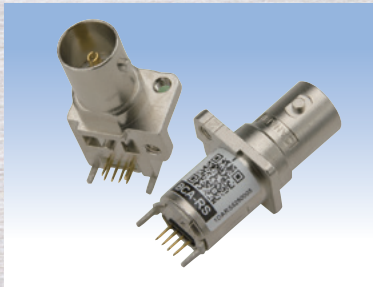

75Ω Mid-size Video Jacks

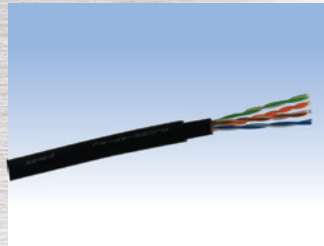

Ethernet Cable



Cable Reel Snake

Cable Assemblies



# CONTENTS

## Fiber-Optic Systems

2	Overview
7	EO/OE Converters, Repeater
12	Mux/Demux, Optical Splitter
13	Platform, SFP Transceiver
14	HFO Transmission Devices
16	HFO Camera Cables
20	HFO Camera Connector Panels
20	HFO Camera Connector Panels, Splice Enclosures
22	HFO Camera Cable Checkers
23	Fiber-optic Cables

## Connectors

26	Overview
27	Active BNC
28	75Ω DIN Connectors
29	75Ω Multichannel Coax Connectors
30	75Ω BNC Connectors
36	75Ω N Connectors
37	75Ω Triaxial Connectors
38	RCA Connectors
39	F Connectors, Phone Plugs
40	50Ω BNC Connectors
41	50Ω TNC, N, SMA Connectors
42	Cable Stripper, Crimp Tools
45	Impedance Transformers

## Cables

46	Q&A
48	Star Quad Microphone Cables
51	Two-conductor Shielded Cables
55	AES/EBU Digital Audio Cables
56	Speaker Cables
58	OFC Line, DMX, RS422 Cables
59	Ethernet Cables
60	75Ω Coaxial Cables
61	75Ω Coaxial Cables, 75Ω Triaxial Cables
62	75Ω Multichannel Coaxial Cables
63	A/V Composite Cables, 50Ω Coaxial Cables
64	Technical Note
65	Nominal Attenuation

## Connector Panels and Patchbays

66	75Ω Video Patchbays
67	75Ω Mid-size Video Patchbays
68	Video Plugs
69	Ordering Information
70	Unloaded Video Jack Panels, RS422 Patchbays
71	Connector Panels
73	Audio Patchbays

## Multichannel Systems

75	Overview
76	Snake Trunks, Cable Reel Snakes
77	Fantails, Junction Boxes
78	Pin Assignments
79	Reels

## Cable Assemblies

80	BNC, DIN
81	RCA (video), Triax, Video Patch, RS422, DMX
82	Ethernet
83	XLR, Phone
84	RCA (audio), Speaker, Audio Patch
85	Digital Audio, Analog Audio
86	HDMI
87	DVI, VGA
88	VGA, RCA



### Trunk Lines at the Moment

#### ■ Migrating to Fiber Optics

Trunk lines carry many different kinds of signals—video, synchronization, audio, control, power supply—and consequently they're usually comprised of numerous different types of cables. As a result, conduits, electrical pits, and ladders tend to overflow with cabling, leaving hardly any room when lines must be added to upgrade or expand the system.

But, converting these disparate signals into optical signals and transmitting them using fiber optic cables greatly reduces the need for so many specialized cables. Converting trunk lines to fiber optics makes it much easier to design and upgrade equipment and systems, because once laid these lines can be used with considerable flexibility. Fiber optic cables also have smaller diameters, meaning they take up less space, a clear advantage in alleviating some of the problems of today's cable-stuffed broadcasting facilities.

#### ■ Sending HD Signals Everywhere

HD-SDI signals can be transmitted only about 100 meters over standard coaxial cables (5C-FB). This means that when wiring rooms and buildings with coaxial cables, it's sometimes difficult to achieve an optimal layout or position equipment where it will be most convenient and useful. Further, signal transmissions often need to cover unexpectedly long distances, and fiber optic cables, with their transmission distance measured in tens of kilometers, win hands-down over coaxial cables. This flexibility alleviates much of the conventional worry about cable routing and allows the equipment itself to take center stage.

The cost of optical signal converters has dropped radically, too—most can be had for a few hundred dollars—making it difficult these days to find reasons not to introduce fiber optic systems!

#### Cable Diameters

Even with 100 cores (lines), a fiber optic cable has an external diameter of just 11.5 mm. Compare that to a typical coaxial cable and the difference is clear.

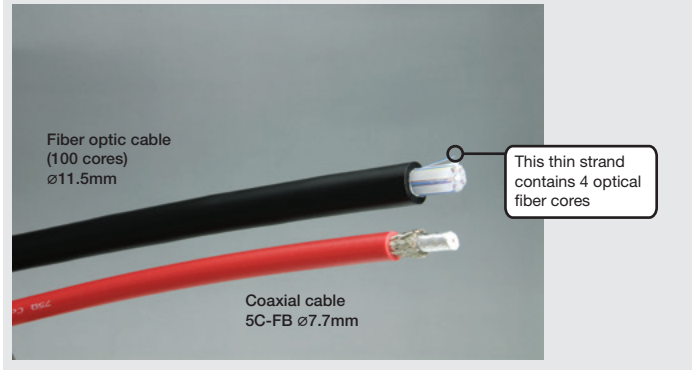

#### Example of an Optical Fiber Trunk Line

Fiber optic systems are used in signal transmissions within a single broadcast station, or between a main building and an annex building.

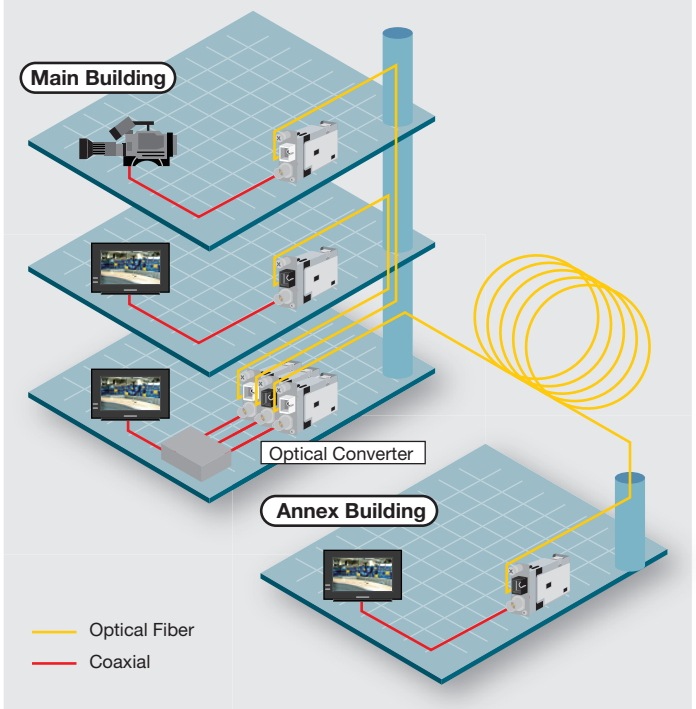

### Diversified Needs for Optical Conversion

#### ■ It is not just the HD-SDI signal

It is not just the HD-SDI signal that is converted into optical signals. For example, there is a case in which the HD-SDI signal is converted into optical signals along with the control signal to transmit video images during recording in a studio. Converting various signals into optical signals allows them to be transmitted through fiber-optic cables, eliminating the necessity of separately preparing metal cables.

#### ■ Advantages of Fiber Optic Transmission in the Field

With it now so easy to convert transmissions into optical signals, fiber optic systems are better suited than ever to field recording applications. Newly developed extra-strong, extra-bendable optical fibers have finally reduced past concerns about cable durability, meaning that in applications like remote broadcasting, video, audio and other signals can all be transmitted on a single cable, one of the inherent merits of fiber optic systems.

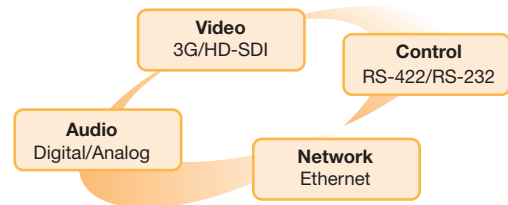

#### Tough & Flexible HFO Camera Cable



(See page 18)



## Important Fiber Optic Line Considerations

### Minimum Light Receiving Power

In optical transmission, transmission quality is evaluated by the relationship between "light receiving power" and "error rate." Error rate is dependent upon the signal to noise ratio (S/N), but since the noise level is thought of as being at a set level independent of the signal strength, the strength of the signal (light receiving power) at the receiver influences S/N considerably, in turn affecting the error rate. Therefore, to maintain a specified transmission quality, it is necessary to design light receiving power to be above the minimum light receiving power of the receiver.

The graph at right shows the light receiving power and error rate within the combination of the EO-100B and OE-151. From this graph, we can estimate that to get an error rate of  $2 \times 10^{-18}$  (to ensure a probability of 1 for transmission errors during 10 years of continuous operation), the light receiving power of the OE-151 must be set greater than -24.3dBm assuming the signal source and EO-100B are connected by a coaxial cable 1 meter in length (SMPTE connection standard). If the signal source and EO-100B are connected by a coaxial cable 190 meters in length, then the OE-151 light receiving power must be more than -23.6dBm, from which we can see that the light receiving power deteriorates by about 1dB as compared with the connection standard.

### Loss Budget (LB)

Loss budget is the difference between the optical power output (P1) from the EO converter and the light reception sensitivity (P2) of the OE converter.

$$LB = P1 - P2$$

Example) If the optical power output P1 = -3.5dBm and the reception sensitivity P2 = -24dBm:



$$LB = -3.5\text{dBm} - (-24\text{dBm}) = 20.5\text{dB}$$

In EO/OE system design, 1) cable attenuation loss, 2) connector insertion loss, 3) fusion splice connection loss, and 4) Mux/Demux insertion loss have to be calculated so that they are less than the loss budget (LB) of the optic link. For HD/SD-SDI system, since the Mux/Demux loss is greater than that of the fiber attenuation loss, it would be essential you to consider such loss elements when you configure the system.

Light Receiving Power and Error Rate

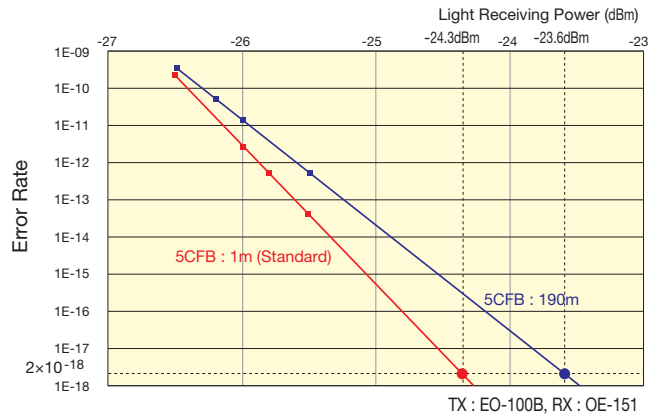

Loss Budget Diagram

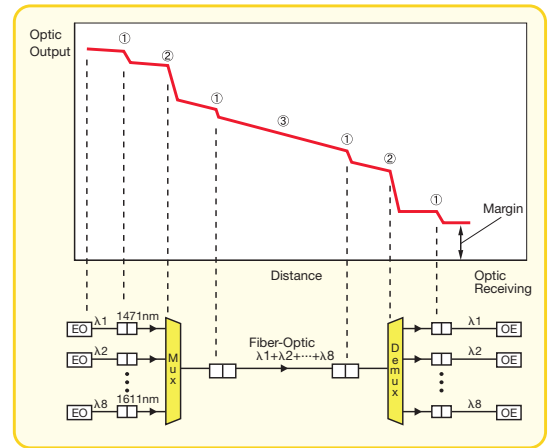

Loss Attenuation

Loss Factor	Value
① Connector Insertion Loss	0.5dB/Point
② Mux/Demux	2~3dB/Point
③ Fiber Cable	0.3dB/km(*)
Splitter	0.5dB/Main 10dB/Branch
Divider	3dB/Point
Fusion Splice Loss	0.2dB/Point
System Margin	2~6dB

\* 0.5~1.0dB/km for Dark fiber



### EO/OE Converter Line-up

Canare's EO/OE product line-up has expanded. A large variety of signals can be sent over fiber-optic cables with a simple set-up. Canare EO/OE will break your system free from distance limitations, signal delays, and noise problems.

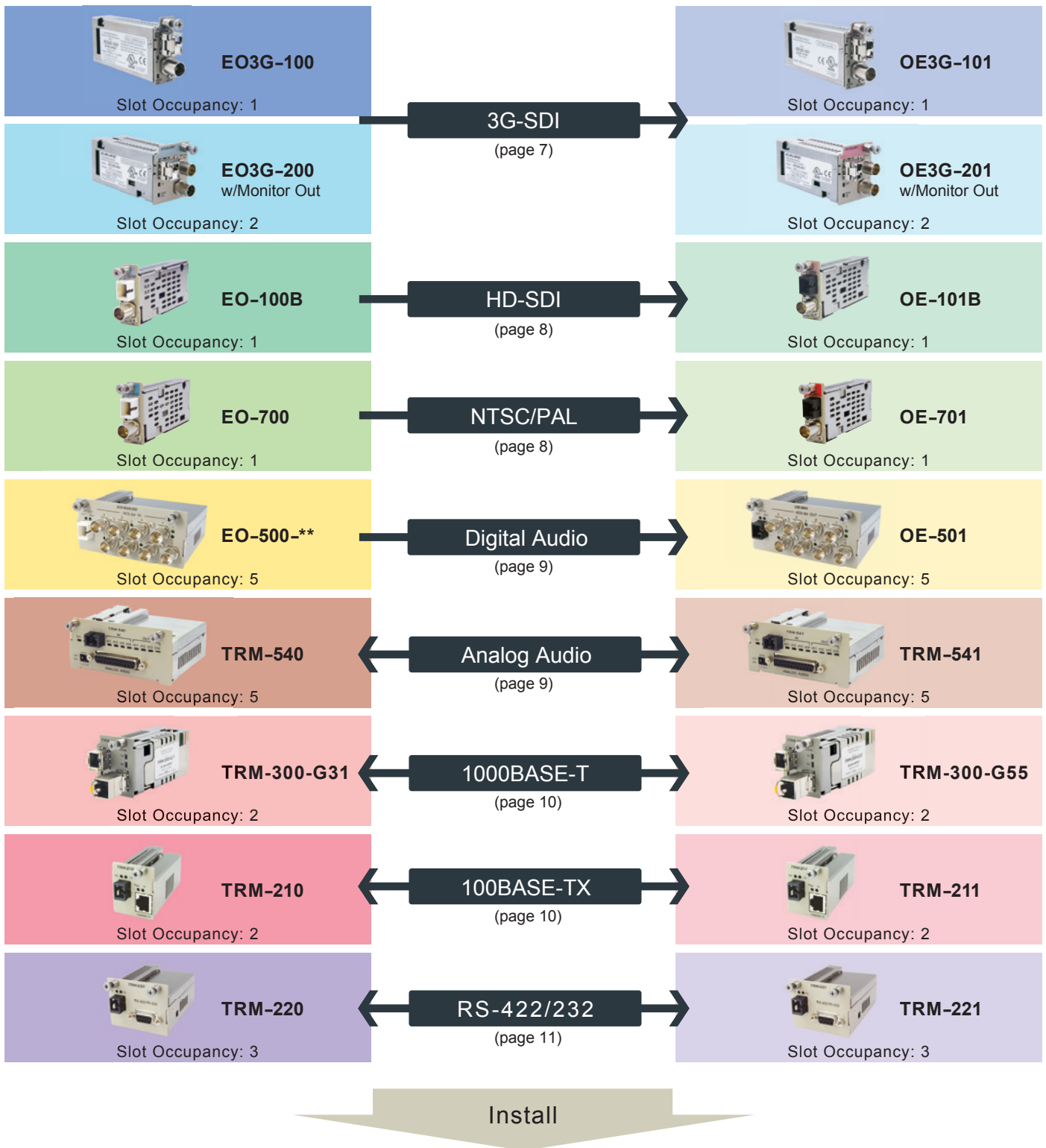

### Platforms (page 13)





# Welcome to a Canare EO/OE Stadium

Please take a look at how a Canare EO/OE system fits perfectly in a modern stadium that handles variety of signal formats such as 3G-SDI/HD-SDI, RS-422/232, 100BASE-TX, and analog audio.

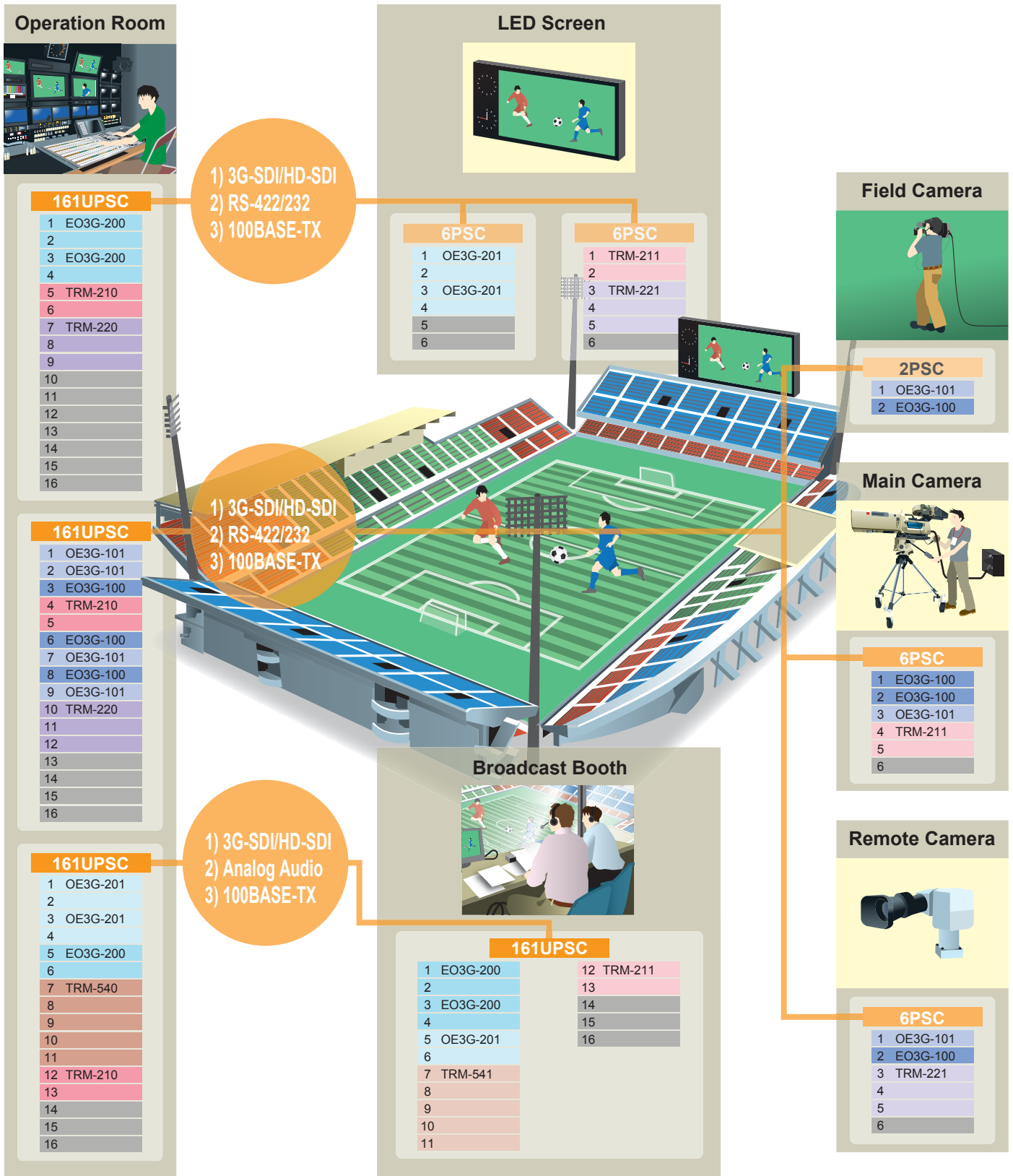

Canare EO/OE products offer smart solutions to stadium or arena AV systems which require broadcast quality video, audio, and data signals. Plug-and-play modular style optical converters can be easily installed. Fiber optic cable based distribution has many advantages, such as long distance transmission, low latency, noise free, and much more!

### Wavelength Multiplexing Systems

#### Multiplexing

“Multiplexing” is a technology that allows multiple signals with different wavelengths to be transmitted together over a single optical fiber. Three general types of multiplexing — WDM, CWDM and DWDM — offer increasing signal-carrying capacities, as described below.

#### Wavelength Division Multiplexing (WDM)

WDM is the simplest form of multiplexing and uses two wavelengths of 1310nm and 1551nm. Unlike when using an optical divider, insertion loss can be kept below 0.5dB.

#### Coarse Wavelength Division Multiplexing (CWDM)

CWDM systems use 8 wavelengths (20nm grid) primarily between 1471nm and 1611nm. To these it is also possible to add 8 more between 1271nm and 1451nm to allow a maximum of 16 wavelengths to be carried as a single multiplexed transmission. An ultra-thin membrane filter on the optical multiplexer/demultiplexer (mux/demux) keeps insertion loss at just 2-3dB.

\*CWDM standardized through ITU G695.

#### Optical Converter (TX for CWDM)

Canare's CWDM optical converter uses a DFB laser, which offers a much tighter spectrum than FP lasers. Up to 16 different wavelengths fall within 1271nm and 1611 nm in 20nm intervals. The wavelengths in the 20nm grid between 1391nm and 1411nm are not used because their proximity to the water peak results in too much attenuation.

Optical Fiber Transmission Loss Characteristics

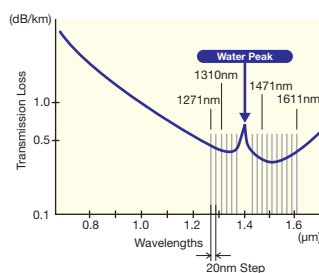

#### Optical Multiplexer/Demultiplexers

The optical signals output from the optical converter (TX) are combined into a single signal by the multiplexer (mux) and transmitted along a single optical fiber. At the receiving end, these combined optical signals are demultiplexed (demux) to split them back into their original component 8 signals.

Optical mux/demuxes are bi-directional, so the same model can be used for transmitting and receiving on each end. It's also possible to use 4 wavelengths out of the 8 for transmitting and the remaining four for receiving. Both 8-wavelength and 16-wavelength models are available, and combining these with an optical converter allows a variety of system constructions with many uses.

#### Optical Converter (RX)

Canare's optical converter (RX) converts an optical signal comprised of 8 different wavelengths into electrical signals. This converter is common to all wavelengths and one converter is required for each wavelength.

Once optical fiber cables have been laid, multiplexing the transmissions carried on them eliminates the need to purchase and install new cables when more transmission lines are needed.

Eight Canare optical converters and an FCWDM-8B mux/demuxer can be installed compactly on a single 161UPSC 1RU-size platform, effectively allowing an 8-wavelength transmission system to be achieved in just 1RU of space.

#### Multiplexing (CWDM)

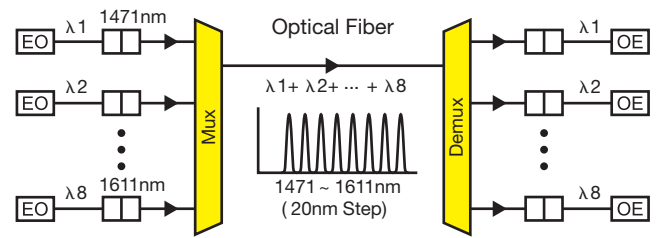

#### 8-wavelength CWDM system example

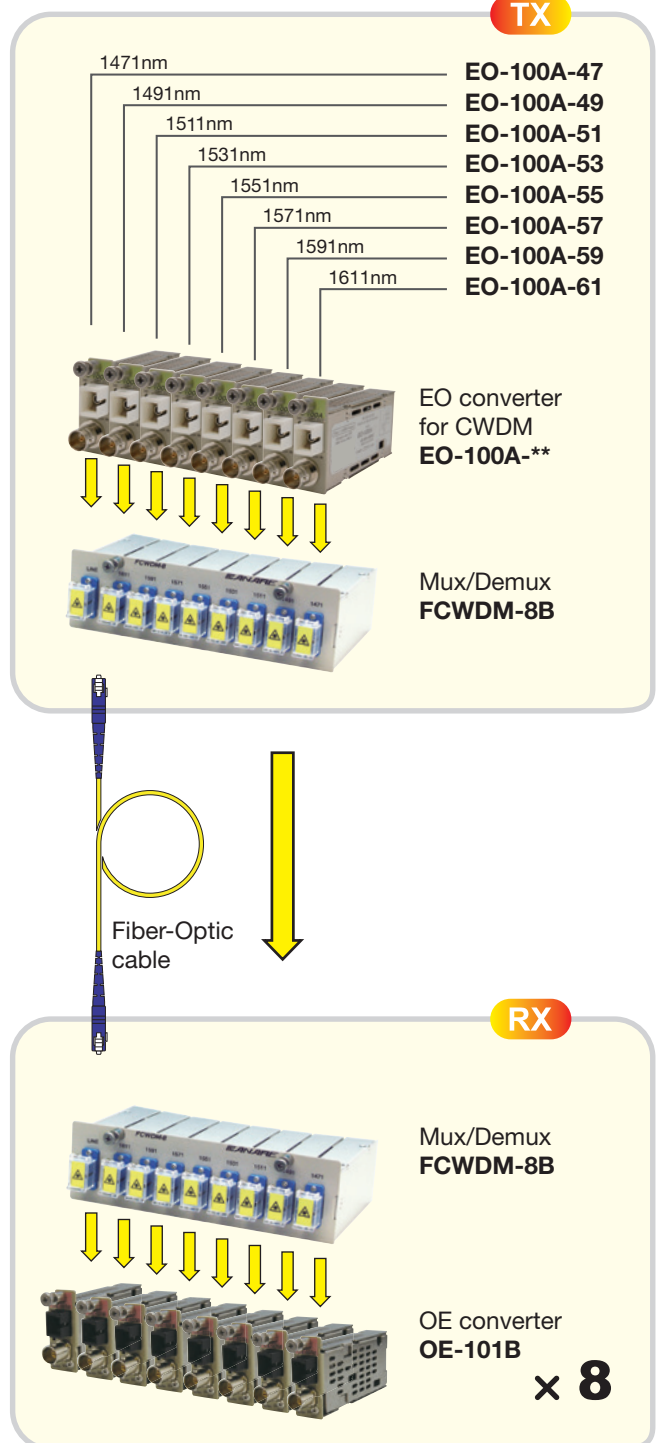

Note: Please use with Canare platform.



3G-SDI EO/OE Converters

Canare EO3G/OE3G series, the new line of 3G-SDI capable optical converters are ideal for applications that require the signal quality and integrity to be at its best over long distance transmissions such as in mobile productions, event venues, and within or between broadcast facilities.

Electric to Optic Converter (TX)

Model	Wavelength	Emission	Monitor Out	Occupancy
EO3G-100	1310 nm	-5 dBm	No	1 slot
EO3G-200			Yes	2 slots
EO3G-100A-**	1271-1611 nm for CWDM*	+2.5 dBm	No	1 slot

\*Refer to the following information to specify the wavelength and the model number.

Optic to Electric Converter (RX)

Model	Wavelength	Sensitivity	Monitor Out	Occupancy
OE3G-101	1200-1620 nm	-22 dBm	No	1 slot
OE3G-201			Yes	2 slot

Key Features and Benefits

- Multi format - 3G-SDI, HD-SDI, SD-SDI, and DVB-ASI
- EO3G-200 and OE3G-201 are equipped with Monitor output port.
- Super low-latency
- Compact size
- Easy to use; requires no complicated settings.
- Supports pathological test pattern
- Cost effective

Specifications

Model	EO3G-100	EO3G-200	EO3G-100A	OE3G-101	OE3G-201
Convertibility	Electric to Optic			Optic to Electric	
Optical Connector	1 x LC (output)			1 x LC (input)	
Fiber Type	Single Mode				
SDI Input	1 x 75 Ω BNC	1 x 75 Ω BNC	1 x 75 Ω BNC	N/A	N/A
SDI Output	N/A	1 x 75 Ω BNC (no-reclocked)	N/A	1 x 75 Ω BNC	2 x 75 Ω BNC
Dimensions (mm)	17 x 43.4 x 78.4	35.5 x 43.4 x 78	17 x 43.4 x 78.4	17 x 43.4 x 78.4	35.5 x 43.4 x 78
Weight (approx.)	100 g	150 g	95 g	100 g	150 g
Typical Compliances	SMPTE 259M, 292M, 297-2006, 424M, EN50083-9				

3G-SDI Repeater

Equalizes and reclocks 3G/HD/SD-SDI signals to extend the transmission distance over a coaxial cable.

Model	Support Formats/Rates	Occupancy
EE3G-100	3G-SDI, HD-SDI, SD-SDI, DVB-ASI	1 slot

Key Features and Benefits

- Typical cable equalization: 100 m of L-5CFB in 3G-SDI
- Supports 3G/HD/SD-SDI and DVB-ASI
- Passes embedded audio
- Allows for efficient use of existing cable infrastructure.

Specifications

I/O Connector	2 x 75 Ω BNC
Typical Compliances	SMPTE 424M, 292M, 259M, EN50083-9

Example of Use

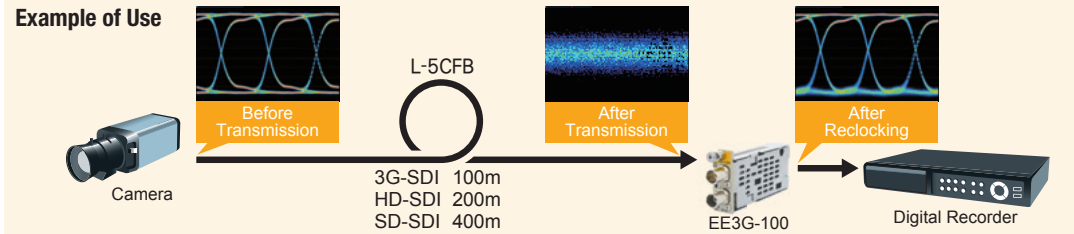

Note: Platform (power supply) is required to use Canare optical converters (see page13).



EO3G-100 (TX)



EO3G-200 (TX with Monitor Output)



OE3G-101 (RX)

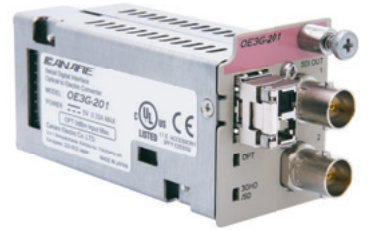

OE3G-201 (RX with Monitor Output)

Ordering Information for EO3G-100A-\*\*

EO3G-100A- [ ]	Wavelength
27	1271 nm
29	1291 nm
31	1311 nm
33	1331 nm
35	1351 nm
37	1371 nm
43	1431 nm
45	1451 nm
47	1471 nm
49	1491 nm
51	1511 nm
53	1531 nm
55	1551 nm
57	1571 nm
59	1591 nm
61	1611 nm



EO3G-100A-\*\* (TX)



EE3G-100

Dimensions : 17 x 43.4 x 78.4 mm  
Weight : 85g

### HD-SDI EO/OE Converters

#### Electric to Optic Converters (TX)

Model	Wavelength	Emission	Reclocker	Occupancy
EO-100B	1310 nm	-3.5 dBm	Yes	1 slot
EO-160			N/A	
EO-100A-**	1271-1611 nm for CWDM*	-2.5 dBm	Yes	

\*Refer to the following information to specify the wavelength and the model number.

#### Optic to Electric Converters (RX)

Model	Wavelength	Sensitivity	Reclocker	Occupancy
OE-101B	1200-1620nm	-24 dBm	Yes	1 slot
OE-151			N/A	

#### Key Features and Benefits

- Multi format - HD-SDI (up to 1.485 Gbps), SD-SDI and DVB-ASI
- Embedded audio capable
- Handles pathological test pattern
- No-reclocker models support wide bit rate range. (50 Mbps to 1485 Mbps)
- Compact design - Maximum 16 modules within 1RU
- Hot swappable
- Cost effective
- Easy to use - BNC and SC-type connector.

#### Specifications

Model	EO-100B, EO-160	EO-100A-**	OE-101B, OE-151
Convertibility	Electric to Optic		Optic to Electric
Fiber Type	Single Mode		
Optical Connector	1 x SC (output)		1 x SC (input)
SDI Connector	1 x 75 Ω BNC (input)		1 x 75 Ω BNC (output)
Dimensions	17 x 43.4 x 78.4 mm		
Weight	77 g	58 g	77 g
Typical Compliances	SMPTE 259M, 292M, 297-2006, EN50083-9		



#### Ordering Information for EO100A-\*\*

EO-100A-47	Wavelength
27	1271nm
29	1291nm
31	1311nm
33	1331nm
35	1351nm
37	1371nm
43	1431nm
45	1451nm
47	1471nm
49	1491nm
51	1511nm
53	1531nm
55	1551nm
57	1571nm
59	1591nm
61	1611nm



### Analog Video Optical Converters

Model	Wavelength	Emission	Sensitivity	Occupancy
EO-700	1310 nm	-3.5 dBm	N/A	1 slot
EO-700A-**	1471-1611 nm for CWDM*	-2.5 dBm	N/A	
OE-701	1200-1620 nm	N/A	-26 dBm	

\*Refer to the following information to specify the wavelength and the model number.

#### Key Features and Benefits

- Supports both NTSC and PAL video signals.
- Tri-level sync can be transmitted.
- SNR: 60 dB, Bandwidth: 6 MHz

#### Specifications

Model	EO-700, EO-700A	OE-701
Convertibility	Electric to Optic (TX)	Optic to Electric (RX)
Fiber Type	Single Mode	
Optical Connector	1 x SC (output)	
Video Connector	1 x 75 Ω BNC (input)	
Dimensions	17 x 43.4 x 78.4 mm	
Weight	84 g	
Typical Compliances	SMPTE 170M, ITU-R BT.470	

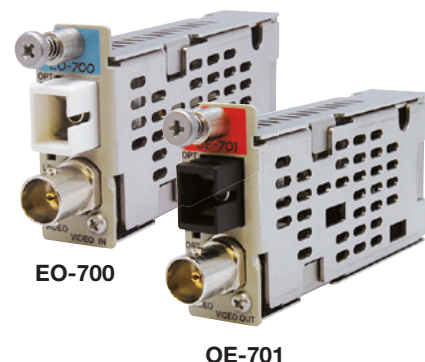

#### Ordering Information for EO-700A-\*\*

EO-700A-47	Wavelength
47	1471 nm
49	1491 nm
51	1511 nm
53	1531 nm
55	1551 nm
57	1571 nm
59	1591 nm
61	1611 nm

Note: Platform (power supply) is required to use Canare converters (see page13).



AES 3id Optical Converters

Model	Wavelength	Emission	Sensitivity	Occupancy
EO-500-**	1471-1611 nm for CWDM*	-3 dBm	N/A	5 slots
OE-501	1200-1620 nm	N/A	-26 dBm	

\* Refer to the following information to specify the wavelength.

Key Features and Benefits

- Multiplex and optically convert AES signals from up to 8 ports (16 audio channels) to allow them to be transmitted over long distance.
- Supports 8 wavelengths CWDM; enables max. 64 ports (128 audio channels) signals to transmit over a single optical fiber.
- AES-3id-1995 and SMPTE 276M
- Fully asynchronous multiplex transmission.
- Word clock can be transmitted (30kHz to 50kHz).
- Dolby-E compatible

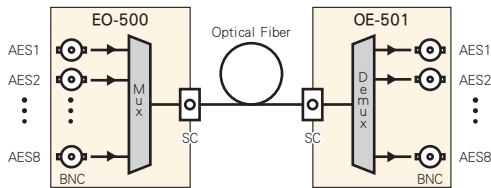

Specifications

Model	EO-500-**	OE-501
Convertibility	Electric to Optic	Optic to Electric
Fiber Type	Single Mode	
Optic Connector	1 x SC (output)	1 x SC (input)
AES I/O Connector	8 x 75Ω BNC (input)	8 x 75Ω BNC (output)
Dimensions	91 x 43.4 x 76.2 mm	
Weight	174 g	
Typical Compliances	AES-3id-1995, SMPTE 276M	

Analog Audio Optical Converters

Model	Wavelength	Occupancy	Remark
TRM-540	1310 nm	5 slots	Work with TRM-541.
TRM-541	1550 nm		Work with TRM-540.
TRM-540A-**	1471-1611 nm for CWDM (*1)		Work with TRM-540A-** of a different wavelength (*2).

\*1) Refer to the following information to specify the wavelength and the model number.)  
 \*2) TRM-540A-\*\* does not work with TRM-540 or TRM-541.

Key Features and Benefits

- Enables line level audio signals to transmit long distance over a fiber-optic cable.
- 8 channel transmission (4-channel inputs/4-channel outputs)
- Maximum input/output voltage: +24 dBu (balanced)
- Supports 600 ohm input by each channel with selector switches.

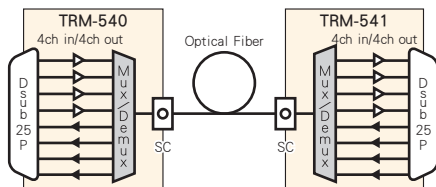

Block Diagram of TRM-540 and TRM541

Specifications

Model	TRM-540, TRM-541	TRM-540A-**
Fiber Type	Single Mode	
Optic I/O Connector	1 x SC	2 x LC
Audio I/O Connector	1x D sub 25 pin (F)	
Frequency Response	20 Hz - 40 kHz (-3 dB, +0.1 dB)	
Dimensions	91 x 43.4 x 78.4 mm	
Weight	265 g	



EO-500-55



OE-501

Ordering Information for EO-500-\*\*

EO-500- 47	Wavelength
47	1471 nm
49	1491 nm
51	1511 nm
53	1531 nm
55	1551 nm
57	1571 nm
59	1591 nm
61	1611 nm



TRM-540



TRM-541

Ordering Information for TRM-540A-\*\*

TRM-540A- 47	Wavelength
47	1471 nm
49	1491 nm
51	1511 nm
53	1531 nm
55	1551 nm
57	1571 nm
59	1591 nm
61	1611 nm

Note: Platform (power supply) is required to use Canare converters (see page13).

### 1000BASE-T Optical Converters

Model	Wavelength	Occupancy	Remark
TRM-300-G31	1310 nm	2 slots	Work with TRM-300-G55.
TRM-300-G55	1550 nm		Work with TRM-300-G31.
TRM-300A-G**	1471-1611 nm for CWDM (*1)		Work with TRM-300A-G** of a different wavelength (*2).

\*1) Refer to the following information to specify the wavelength and the model number.  
 \*2) TRM-300A-G\*\* does not work with TRM-300-G31 or TRM-300-G55.

#### Key Features and Benefits

- Media converters for Gigabit Ethernet 1000BASE-T\*  
 \*No backwards compatibility with other Ethernet standards such as 100BASE-TX.
- Super-low latency: less than 1 micro-second.
- Extends communications up to 20 km (condition: line loss 0.5 dB/km)
- Bi-directional optical communication

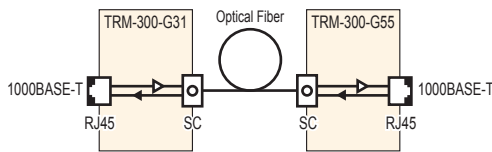

Block Diagram of TRM-300-G31 and TRM-300-G55

#### Specifications

Model	TRM-300-G31, TRM-300-G55	TRM-300A-G**
Fiber Type	Single Mode	
Optic I/O Connector	1 x SC	2 x LC
Ethernet I/O Connector	1 x RJ45	
Dimensions	35.5 x 43.4 x 76 mm	
Weight (approx.)	150 g	
Typical Compliances	IEEE 802.3ab (1000BASE-T)	



TRM-300-G31



TRM-300-G55

#### Ordering Information for TRM-300A-G\*\*

TRM-300A-G	Wavelength
47	1471 nm
49	1491 nm
51	1511 nm
53	1531 nm
55	1551 nm
57	1571 nm
59	1591 nm
61	1611 nm

### 100BASE-TX Optical Converters

Model	Wavelength	Occupancy	Remark
TRM-210	1310 nm	2 slots	Work with TRM-211.
TRM-211	1550 nm		Work with TRM-210.
TRM-210A-**	1471-1611 nm for CWDM (*1)		Work with TRM-210A-** of a different wavelength (*2).

\*1) Refer to the following information to specify the wavelength and the model number.  
 \*2) TRM-210A-\*\* does not work with TRM-210 or TRM-211.

#### Key Features and Benefits

- Media converters for Fast Ethernet 100BASE-TX\*  
 \*No backwards compatibility with other Ethernet standards such as 10BASE-T.
- Auto MDI/MDX
- Extends communications up to 30 km (condition: line loss 0.5 dB/km)
- Bi-directional optical communication

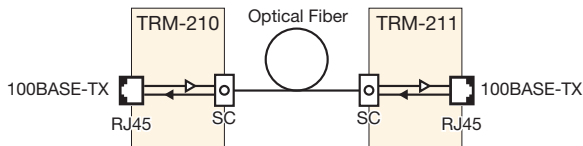

Block Diagram of TRM-210 and TRM-211

#### Specifications

Model	TRM-210, TRM-211	TRM-210A-**
Fiber Type	Single Mode	
Optic I/O Connector	1 x SC	2 x LC
Ethernet I/O Connector	1 x RJ45	
Dimensions	35.5 x 43.4 x 76.2 mm	
Weight (approx.)	103 g	110 g
Typical Compliances	IEEE 802.3u (100BASE-TX)	



TRM-210



TRM-211

#### Ordering Information for TRM-210A-\*\*

TRM-210A-	Wavelength
47	1471 nm
49	1491 nm
51	1511 nm
53	1531 nm
55	1551 nm
57	1571 nm
59	1591 nm
61	1611 nm

Note: Platform (power supply) is required to use Canare converters (see page13).



RS-422/RS-232 Optical Converters

Model	Wavelength	Occupancy	Remark
TRM-220	1310 nm	3 slots	Work with TRM-221.
TRM-221	1550 nm		Work with TRM-220.
TRM-220A-**	1471-1611 nm for CWDM (*1)		Work with TRM-220A-** of a different wavelength (*2).

\*1) Refer to the following information to specify the wavelength and the model number.  
 \*2) TRM-220A-\*\* does not work with TRM-220 or TRM-221.

Key Features and Benefits

- TIA-422, SMPTE 207M, RS-232
- Usable in a case of RS-422 <=> RS-232
- Extends communications up to 30 km (condition: line loss 0.5 dB/km)
- Bi-directional optical communication

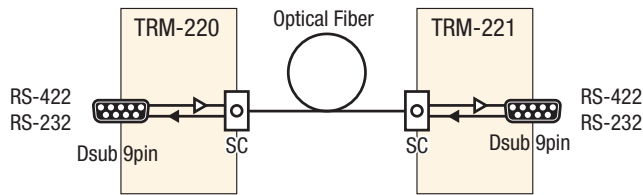

Block Diagram of TRM-220 and TRM-221



TRM-220

TRM-221

Ordering Information for TRM-220A-\*\*

TRM-220A- [47]	Wavelength
47	1471 nm
49	1491 nm
51	1511 nm
53	1531 nm
55	1551 nm
57	1571 nm
59	1591 nm
61	1611 nm

Specifications

Model	TRM-220, TRM-221	TRM-220A-**
Fiber Type	Single Mode	
Optic I/O Connector	1 x SC	2 x LC
Serial I/O Port	1 x Dsub 9 pin (F)	
Max. Data Rate	RS-422: 10 Mbps, RS-232: 1 Mbps	
Dimensions	54 x 43.4 x 76.2 mm	
Weight (approx.)	110 g	120 g
Typical Compliances	TIA-422, SMPTE 207M, RS-232C	

More Converters

Model	Occupancy
TRM-100	3 slots
TRM-101	

Multiplex and optically convert HD-SDI and RS-485 signal to transmit long distance over a fiber-optic cable. Suited for HD surveillance camera system.

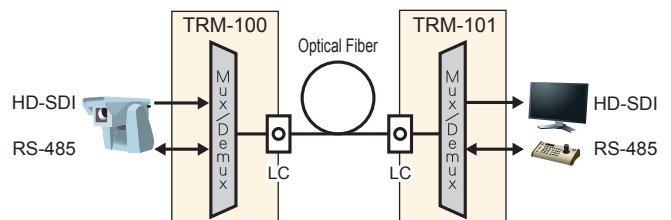

Model	Occupancy
TRM-400	3 slots
TRM-401	

Multiplex and optically convert analog video, stereo audio, RS-422, and contact signals to transmit long distance over a fiber-optic cable.

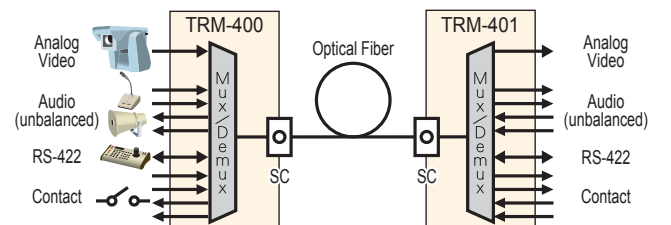

Model	Occupancy
TRM-230	3 slots
TRM-231	

Multiplex and optically convert 7 of each input/output contact signal and RS-422/232 signals to transmit long distance over a fiber-optic cable.

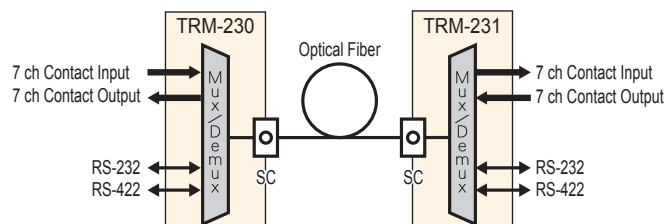

Note: Platform (power supply) is required to use Canare converters (see page13).

### CWDM Mux/Demux

#### Slot-in Module Types

Model	Ch.	Wavelengths	Occupancy
FCWDM-8B	8	1471-1611 nm	8 slots
FCWDM-8B-13	8	1271-1451 nm	

#### Rack Mount Types

Model	Ch.	Wavelengths	Size
FCWDM8/1A	8	1471-1611 nm	1RU
FCWDM8/1A-13	8	1271-1451 nm	
FCWDM8/2A	2 each of 8	2 each of 1471-1611 nm	
FCWDM8/2A-13	2 each of 8	2 each of 1271-1451 nm	
FCWDM16A	16	1271-1611 nm	

#### Key Features and Benefits

- Bi-directional 8 or 16 wavelengths.
- Passive and stand-alone products.
- Easy to use - Just plug in SC-type connectors.
- FCWDM-8B(-13) can be loaded into 161UPSC; enables 8-wavelength CWDM within 1RU frame.

<Loading example (rear view of 161UPSC)>

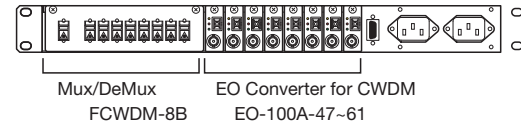

#### Specifications

Model	FCWDM-8B (-13)	FCWDM8/1A (-13)	FCWDM8/2A (-13)	FCWDM16A
Connectors	SC			
Passband	+/- 6.5 nm (ITU-T G.695)			
Min. Passband Ripple	0.5 dB			
Max. Insertion Loss*	2.0 dB		3.3 dB	
Min. Isolation	30 dB			
Dimensions (mm)	146 x 43.4 x 94.2	482.6 x 44 x 362.3		
Weight (approx.)	210 g	1700 g	1800 g	1890 g
Wavelengths Details (nm)	1271-1451: 1271/1291/1311/1331/1351/1371/1431/1451 1471-1611: 1471/1491/1511/1531/1551/1571/1591/1611			

\* Insertion loss includes ripple, PDL, and connector loss



FCWDM-8B



FCWDM8/1A (Rear View)



FCWDM8/2A (Rear View)



FCWDM16A (Rear View)

### Optical Splitter

Model	Wavelength	Description
FDM-2	1261-1611nm	1x2 Splitter for Single Mode Fiber
FDM-4		1x4 Splitter for Single Mode Fiber

#### Key Features and Benefits

- Divides single optical input into multiple optical output.
- Passive and stand-alone products.
- Can be loaded into platform for Canare plug-in unit.
- Easy to use - Just plug in SC-type connectors.
- Low insertion loss.

#### Insertion Loss

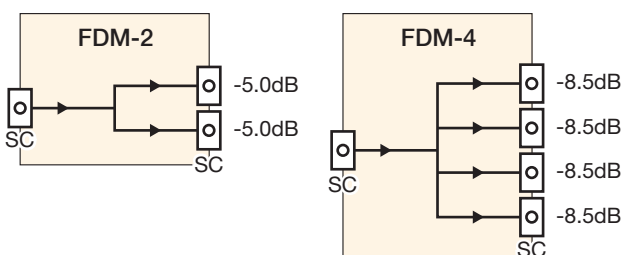

FDM-2

Slot Occupancy : 3 slots  
Dimensions : 54 x 43.4 x 82 mm  
Weight : 83g



FDM-4

Slot Occupancy : 4 slots  
Dimensions : 72 x 43.4 x 82 mm  
Weight : 110g

## Platform

Power supply for Canare plug-in modules. The robust 1RU rack mountable and space efficient portable types are available.

Model	Description	Number of Slots
161UPSC-**	1RU rack mount type	16
6PSC-**	Portable type	6
2PSC	Palm size	2
PSM2-**	Redundant power supply module for 161UPSC	N/A

\* Please fill in the \*\* using the following Region Code.

Type	161UPSC - AU	Region to use (see specifications below)
161UPSC	AU	Oceania
6PSC	C	China
PSM2	EU	EU
	GB	United Kingdom
	JP	Japan
	K	South Korea, no power cord attached
	UC	North America
	N	No power cord attached

\* Please contact us for more detail.

### Key Features and Benefits

- Compact design - Maximum 16 modules within 1RU
- Hot swappable
- 161UPSC can be output 4 types of alarm signals via Dsub 9P (F).
- 161UPSC will require a PSM2 for power supply redundancy.

### Specifications

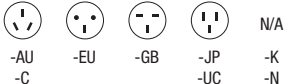
Model	161UPSC	6PSC	2PSC
Number of Slots	16	6	2
AC Input Voltage	100 to 240V 50/60Hz 0.35A		N/A
DC Input Voltage	N/A	10 to 18V	10 to 18V
Max Power Consumption (exclusive of modules)	22W	4.5W (AC) 2.2W (DC)	2.2W
Power Connector	AC3P Jack	AC3P Jack (AC) XLR4 Male (DC)	XLR4 Male
Supply Voltage to Module	DC 5V		
Operating Temperature	-10 to 40°C		
Typical Compliance	CB, CE, UL/cUL, KC (161UPSC-K, 6PSC-K, PSM2-K), FCC15B Class A, RoHS		
AC Power Cord Plug Type		N/A	N/A

## 3G-SDI SFP Optical Transceiver

The Small Form-factor Pluggable transceiver module specified by MSA (Multi-Source Agreement). TRP-300 improves 3G/HD-SDI camera quality through its superior performance in wide range temperature.

Model	Wavelength	Emission	Sensitivity
TRP-300-LN13	FP-LD 1310nm	-5 dBm	-23 dBm

Please contact us for ordering lot.

### Key Features and Benefits

- Supports 3G/HD/SD-SDI
- Canare's exclusive "TC Tech" (Temperature-Compensation Technology)
- Log scale optical power monitoring
- Internal status monitoring via I2C bus

### Specifications

Number of I/O ports	Input: 1, Output: 1
I/O Connector	LC
Fiber Type	Single Mode
Extinction Ratio	9 dB
Transmission Rate	50 Mbps to 2.97 Gbps
Pin Assignment	SFP MSA Compatible
Supply Voltage	3.3 V
Current Consumption	200 mA
Operating Temperature	-25 to 85 deg C
Complians	SMPTE 259M, 292M, 297-2006, 424M BTA S-004B, SFP MSA FDA 21 CFR Part 1040.10, 11 with Laser Notice No.50, IEC 60825-1: 2007, UL/cUL, DEMKO, CE, RoHS



161UPSC-\*\*

Dimensions : 434 x 44 x 340 mm  
Weight : 4500g



6PSC-\*\*

Dimensions : 210 x 44 x 165 mm  
Weight : 650g



2PSC

Dimensions : 90 x 44 x 110 mm  
Weight : 200g

10-slot portable platform is also available.



10PSA-JP

Dimensions: 210 x 44 x 280 mm  
Weight: 1200 g



TRP-300-LN13

Dimensions: 13.9 x 11.85 x 56.5 mm  
Weight: 22g



### 3G-SDI HFO Transmission Device

NEW

Transmit 4 channels of 3G-SDI signals over a HFO camera cable.

Model	HFO Connector	V-plate
FCBA4-FF5W1	FCFRA (Female)	No
FCBA4-FF5W1-PV	FCFRA (Female)	Yes
FCBA4-FM5W2	FCMRA (Male)	No
FCBA4-FM5W2-PV	FCMRA (Male)	Yes

#### Key Features and Benefits

- All-in-one solution 3G-SDI EO/OE modules and power unit.
- The best solution for Quad-link 3G-SDI outside broadcasting.
- Supports 3G-SDI/HD-SDI/SD-SDI and DVB-ASI
- Maximizing existing HFO camera assemblies.
- Flexible configuration for 3G-SDI EO/OE modules.
- AC and DC input redundancy
- Uses one fiber in the HFO camera cable to transmit 4 of 3G-SDI signals, and the other fiber can be utilized by SC throughout connector.

FCBA4-FM5W2



FCBA4-FF5W1



FCBA4-FM5W2-PV

#### <Example of Use>

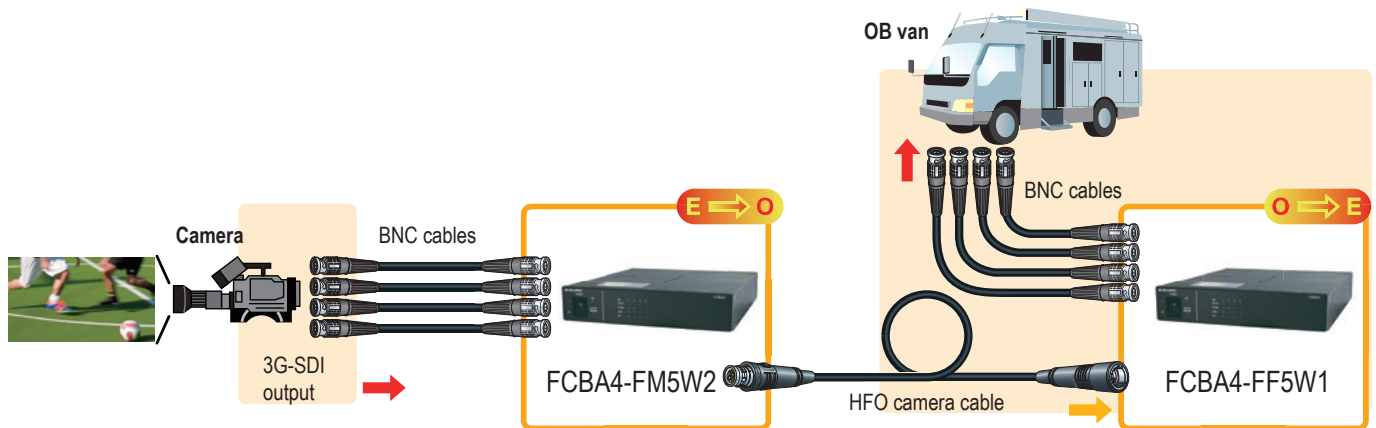

#### Specifications

Model	FCBA4-FF5W1	FCBA4-FF5W1-PV	FCBA4-FM5W2	FCBA4-FM5W2
EO/OE Config	4 x 0E3G-101 (RX)		E03G-100A-47 (TX) E03G-100A-49 (TX) E03G-100A-51 (TX) E03G-100A-53 (TX)	
HFO Connector	FCFRA (Female)		FCMRA (Male)	
SDI I/O Connector	2 x 75 ohm BNC		2 x 75 ohm BNC	
EXT connector	XLR5-31F77 (Female)		XLR5-32F77 (Male)	
Optical connector	SC (for optional use)			
AC Connector	AC 3P Jack			
DC Connector	XLR4-32F77 (Male)	XLR4-32F77 (Male) IDX V-plate	XLR4-32F77 (Male)	XLR4-32F77 (Male) IDX V-plate
Power Requirement	AC 100-240 V DC 10-18 V			
Power Consumption	Max. 5 W			
Operating Temp.	-10 to 40 deg C			
Dimensions (mm)	210 x 42 x 240			
Weight (approx.)	1800 g	1850 g	1800 g	1850 g

Note: UL standards cannot be supported because of its structure.

## HD-SDI HFO Transmission Device

Features Hybrid Fiber-Optic (HFO) camera connector interface with HD-SDI EO/OE modules inside.

Model	HFO Connector	V-plate
FCBA-FF3W1	FCFRA (Female)	No
FCBA-FF3W1-PV	FCFRA (Female)	Yes
FCBA-FM3W2	FCMRA (Male)	No
FCBA-FM3W2-PV	FCMRA (Male)	Yes

### Key Features and Benefits

- All-in-one solution HD-SDI EO/OE modules and power unit.
- Ideal for HD-SDI outside broadcasting.
- Supports HD-SDI/SD-SDI and DVB-ASI
- Maximizing existing HFO camera assemblies.
- Flexible configuration for EO/OE modules.
- AC and DC input redundancy

FCBA-FM3W2



FCBA-FF3W1



FCBA-FM3W2-PV

### <Example of Use>

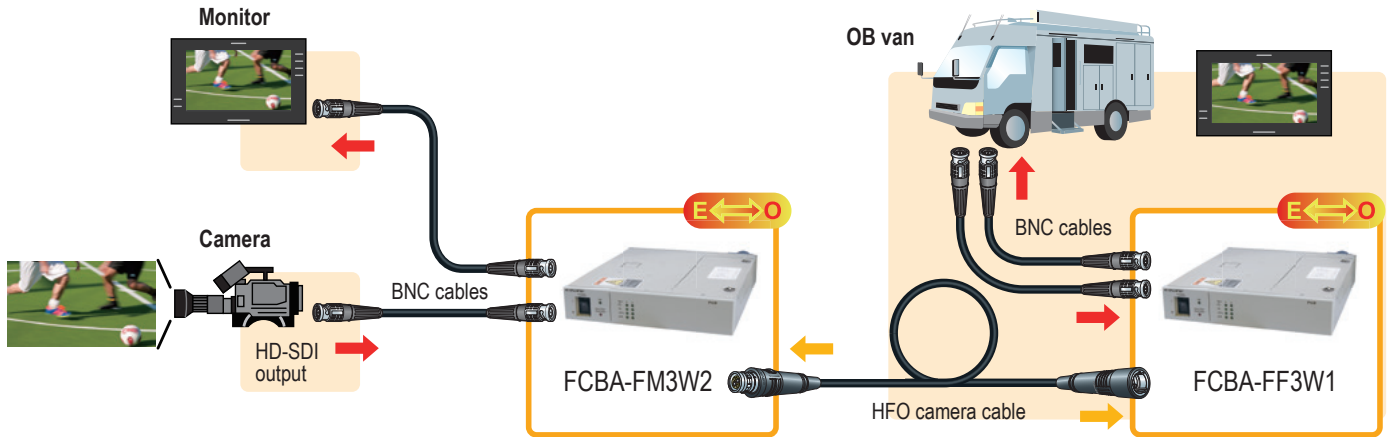



### Specifications

Model	FCBA-FF3W1	FCBA-FF3W1-PV	FCBA-FM3W2	FCBA-FM3W2
EO/OE Config	EO-100B (TX) OE-101B (RX)		OE-101B (RX) EO-100B (TX)	
HFO Connector	FCFRA (Female)		FCMRA (Male)	
SDI I/O Connector	2 x 75 ohm BNC		2 x 75 ohm BNC	
EXT connector	2 x XLR3-31F77 (Female)		2 x XLR3-32F77 (Male)	
AC Connector	AC 3P Jack			
DC Connector	XLR4-32F77 (Male)	XLR4-32F77 (Male) IDX V-plate	XLR4-32F77 (Male)	XLR4-32F77 (Male) IDX V-plate
Power Requirement	AC 100–240 V DC 10–18 V			
Power Consumption	Max. 5 W			
Operating Temp.	-10 to 40 deg C			
Dimensions (mm)	210 x 42 x 240			
Weight (approx.)	1200 g	1250 g	1200 g	1250 g

Note: UL standards cannot be supported because of its structure.

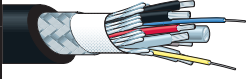
### Hybrid Fiber-optic Camera Cables (SMPTE 311M)

Type	Model	Sales Units (m)	Nom. O.D. (mm)	Weight kg/100m	Outer Jacket	Overall Shield	Tension Tolerance (N)	Strength Member O.D. (mm)	Min. Bend Radius	Temp. Range (deg C)	Channel Unit		
											Fiber	Aux. (Power)	Signal (Control)
 L-2SM9N Jacket color : black	 LF-2SM9N	Call	9.2	12.0	Abrasion-resistance PVC	9/24/0.10TA 91%	700	2.6	6 x Nom. O.D.	-40 to +75	2 x SM 9/125 (low-water-peak) Unit O.D. 0.9 mm	4 x 20 AWG 21 / 0.18TA Unit O.D. 1.7 mm	2 x 25 AWG 7 / 0.18TA Unit O.D. 1.2 mm
	LF-2SM9				Smooth PVC								
	LF-2SM16	Double PVC											

#### LF-2SM9N

- For general use.
- Abrasion-resistance Jacket enhance the adaptability to all studio and outside broadcast applications.
- Cost effective

#### LF-2SM9

- For fixed installation.
- Smooth PVC Jacket brings stress-free cabling.

#### LF-2SM16

- For studio use.
- O.D. 16mm Double Jacket prevents the cable from being jammed under a camera pedestal dolly.

#### Cross Section

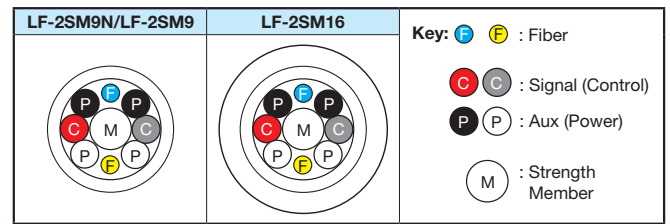

#### Cable Assemblies

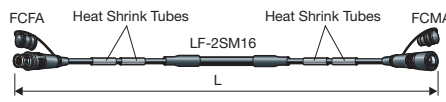
Type	Model	Length (m)
 Jacket color : black	FCC10N	10
	FCC20N	20
	FCC25N	25
	FCC35N	35
	FCC50N	50
	FCC100N	100
	FCC150N	150
 Jacket color : black	FCC200N	200
	FCC30A-WJ	30
	FCC50A-WJ	50
	FCC100A-WJ	100

- Standard and widely-used models.
- Heat shrink tubes help in labeling.
- FCC\*\*A-WJ prevents the cable from being jammed under a camera pedestal dolly by its O.D. 16mm double jacket.
- 7-color connector rings included.

\* TAJIMI compatible type (Canare OC series) is also available. Please contact us for more information.



FCFA



FCMA



Color Rings

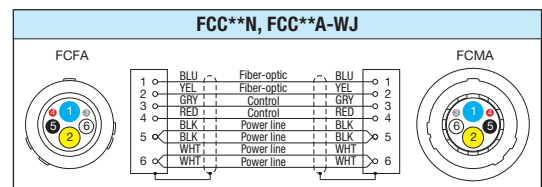

Wiring Diagram



## Slim Hybrid Fiber-optic Camera Cable

Type	Model	Sales Units (m)	Nom. O.D. (mm)	Weight kg/100m	Outer Jacket	Overall Shield	Tension Tolerance (N)	Strength Member O.D. (mm)	Min. Bend Radius	Temp. Range (deg C)	Channel Unit		
											Fiber	Aux. (Power)	Signal (Control)
	<b>LF-2SM7N</b>	Call	7.1	7.3	Abrasion-resistance PVC	8/24/0.10TA 91%	300	1.4	6 x Nom. O.D.	-40 to +75	2 x SM 9/125 (low-water-peak) Unit O.D. 0.9 mm	2 x 20 AWG 21 / 0.18TA Unit O.D. 1.7 mm	2 x 25 AWG 7 / 0.18A Unit O.D. 1.2 mm

Jacket color : black

### LF-2SM7N

- O.D. 7 mm of slim profile and approx. 40% lighter than LF-2SM9N.
- Best fit for mobile applications.
- The power transmission distance is approx. twice as long as the previous model LF-2SM7R.

Note: The power transmission distance is shorter than typical HFO camera cables (approx. 50% of LF-2SM9N). Please contact us for more information.

\*Multichannel cables, LF-2SM7N-3P and LF-2SM7N-5P, are also available.

### Cross Section

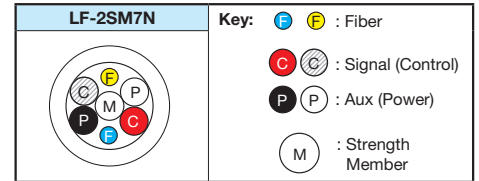

### Cable Assemblies

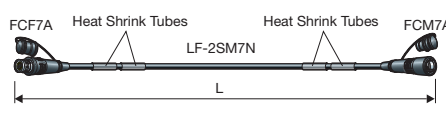
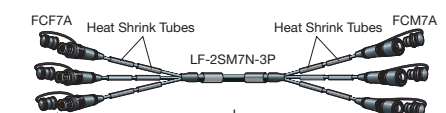
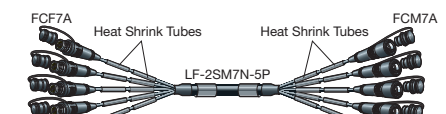
Type	Model	Length (m)
	<b>FCC10-7N</b>	10
	<b>FCC20-7N</b>	20
	<b>FCC30-7N</b>	30
	<b>FCC50-7N</b>	50
	<b>FCC100-7N</b>	100
	<b>F3-FCC10-7N</b>	10
	<b>F3-FCC20-7N</b>	20
	<b>F3-FCC30-7N</b>	30
	<b>F3-FCC50-7N</b>	50
	<b>F3-FCC100-7N</b>	100
	<b>F5-FCC10-7N</b>	10
	<b>F5-FCC20-7N</b>	20
	<b>F5-FCC30-7N</b>	30
	<b>F5-FCC50-7N</b>	50
	<b>F5-FCC100-7N</b>	100

Jacket color: black

- Equipped with slim and lightweight cable.
- FCC100-7N is approx. 5 kg lighter than typical 100m HFO camera cable as FCC100N.
- Heat shrink tubes help in labeling.
- 7-color connector rings included.

Note: The power transmission distance of FCC\*\*-7N is approx. half of that of the FCC\*\*N.

\*TAJIMI compatible type (Canare OC series) is also available. Please contact us for more information.



FCF7A

FCM7A



Color Rings

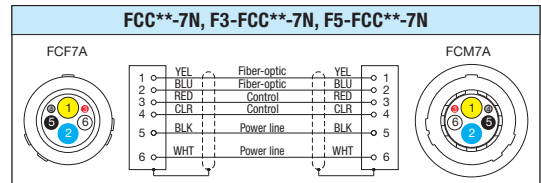

FCC\*\*-7N



F5-FCC10-7N

### Tough & Flexible HFO Camera Cable

NEW

Thermoplastic polyurethane type jacket offers amazing flexibility and superior mechanical properties; Crush Resistance, Impact Resistance and Cyclic Flexing exceed that of MIL.

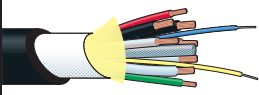
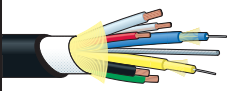
Type	Model	Sales Units (m)	Nom. O.D. (mm)	Weight kg/100m	Outer Jacket	Overall Shield	Tension Tolerance (N)	Strength Member O.D.	Min. Bend Radius	Temp. Range (deg C)	Channel Unit		
											Fiber	Aux. (Power)	Signal (Control)
 Jacket color : black	LF-2SM9T	Call	9.2	9.8	TPU + PVC	N/A	1500	1.8 mm + Tensile strength fiber	Equal to Nom. O.D.	-40 to +75	2 x SM 9/125 (low-water-peak) Unit O.D. 0.9 mm	4 x 20 AWG 102 / 0.08A Unit O.D. 1.75 mm	2 x 25 AWG 24 / 0.08A Unit O.D. 1.2 mm
 Jacket color : black	LF-2SM7T	Call	7.1	5.3	TPU + PVC	N/A	1000	0.63 mm + Tensile strength fiber	Equal to Nom. O.D.	-40 to +75	2 x SM 9/125 (low-water-peak) Unit O.D. 1.7 mm	2 x 23 AWG 60 / 0.08A Unit O.D. 1.4 mm	2 x 26 AWG 30 / 0.08A Unit O.D. 1.1 mm

#### LF-2SM9T

- Heavy-duty yet Flexible.
- Ideal for remote broadcast applications.
- Minimum bend radius: 9.2 mm.

#### LF-2SM7T



- Flexible, Slim, Lightweight, and moreover, Heavy-duty.
- Ideal for short-distance remote broadcast applications of up to 200 meters.
- O.D. 7.1mm and weighing only 5.3 kg/100 m, it's so easy to carry around.
- Minimum bend radius: 7.1 mm.
- Fiber units include tensile strength fiber.

Note: The power supply distance of LF-2SM7T is shorter than other HFO camera cables. (approx. 30% of LF-2SM9N)  
LF-2SM7T requires a special technique during a connector assembly, so you can buy the cable assemblies shown below.  
LF-2SM7T cannot be assembled with TAJIMI type connector including Canare OC series.

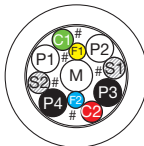
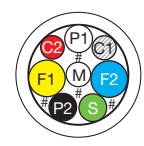
#### Cross Section

LF-2SM9T	LF-2SM7T
	
<b>Key:</b> <span style="color:blue">F1</span> <span style="color:red">F2</span> : Fiber <span style="color:green">C1</span> <span style="color:red">C2</span> : Signal (Control) <span style="color:blue">P1</span> <span style="color:red">P2</span> : Aux (Power) <span style="color:black">P3</span> <span style="color:black">P4</span> : Aux (Power) <span style="color:grey">S1</span> <span style="color:grey">S2</span> : Ground <span style="border:1px solid black; border-radius:50%; padding:2px;">M</span> : Strength Member <span style="color:blue">#</span> : Tensile Strength Fiber	<b>Key:</b> <span style="color:blue">F1</span> <span style="color:red">F2</span> : Fiber + Tensile Strength Fiber <span style="color:red">C1</span> <span style="color:red">C2</span> : Signal (Control) <span style="color:blue">P1</span> <span style="color:red">P2</span> : Aux (Power) <span style="color:green">S</span> : Ground <span style="border:1px solid black; border-radius:50%; padding:2px;">M</span> : Strength Member <span style="color:blue">#</span> : Tensile Strength Fiber

#### Cable Assemblies

Type	Model	Length (m)
 Jacket color : black *Tajimi compatible type is also available.	FCC10-9T	10
	FCC20-9T	20
	FCC25-9T	25
	FCC35-9T	35
	FCC50-9T	50
	FCC100-9T	100
 Jacket color: black *Tajimi compatible type is NOT available.	FCC10-7T	10
	FCC20-7T	20
	FCC30-7T	30
	FCC50-7T	50
	FCC100-7T	100

- Tough & Flexible cable
- Fit for mobile applications in harsh environments.
- Heat shrink tubes help in labeling.
- 7-color connector rings included.

Note: The power transmission distance of FCC\*\*-7T is quite shorter than typical HFO camera cables.



FCC\*\*-7T



FCFA, FCF7A



FCMA, FCM7A



Color Rings

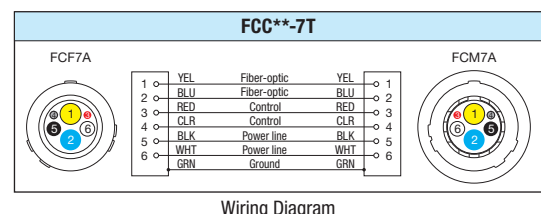
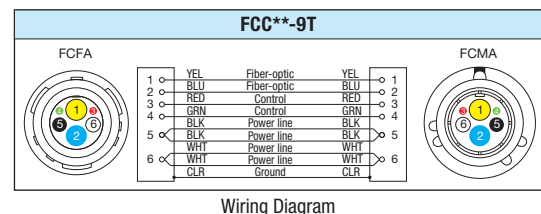

## HFO Camera Cable Assemblies (Flanged Type)

Type	Model	Length (m)
	FCC05A-FRCM	5
	FCC10A-FRCM	10
	FCC05A-FMRC	5
	FCC10A-FMRC	10

\* TAJIMI compatible type (OC series) is also available. Please contact Canare for more information.

- HFO camera cable with the flange for panel mounting.
- SMPTE 304M, 311M, and ARIB BTA S-1005B compliant.
- Return loss: 45dB or greater ( $\lambda = 1.3\mu\text{m}$ ).
- Insertion loss: 0.5dB or less ( $\lambda = 1.3\mu\text{m}$ ).
- Connector body material is stainless steel.
- Color rings and insulation plates included.



Color Rings



IU-FC\*-SET



FCFRCA



FCMRCA

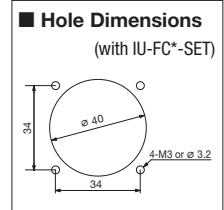

## HFO Camera Receptacle Cables

Type	Model	Length (m)
	FCS015A-FR	1.5
	FCS015A-MR	1.5

\* TAJIMI compatible type (OC series) is also available. Please contact Canare for more information.

- Ideal for connecting wall terminal panels to splice enclosures, etc.
- Return loss: 45dB or greater ( $\lambda = 1.3\mu\text{m}$ ).
- Insertion loss: 0.5dB or less ( $\lambda = 1.3\mu\text{m}$ ).
- Connector body material is stainless steel.
- Insulation plates included.

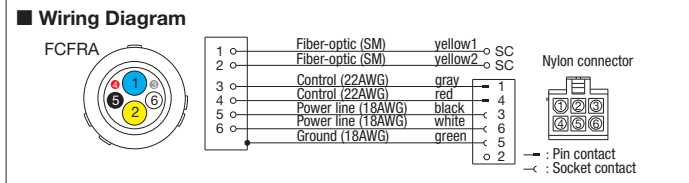

FCFRA



FCMRA

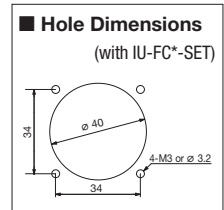

## Insulation Plate

Ideal for perfect insulation between individual connector and panel.

Model	Suitable Connector
IU-FCM-SET	FCMRA, FCMRCA
IU-FCF-SET	FCFRA, FCFRCA

- Material: Bakelite (phenolic resin)
- Mounting screws included.

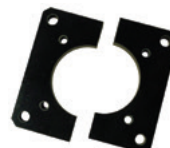

IU-FC\*-SET

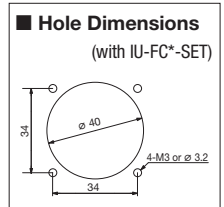

## Extraction Tool

Extraction tool helps easy to clean Canare HFO connectors.

Model	Suitable Connector
ASPT-1	FCFA, FCF7A, FCFRA, FCFRCA

- Tool to be used to release the alignment sleeve unit when cleaning HFO connectors.

\* Use the CLETOP 2.5/2.0 (100) cleaning stick to clean fiber-optic camera connectors.



ASPT-1



Quick-release

US Patent No.7241055B2  
JP Patent No.4340186



### Hybrid Fiber-optic Camera Connector Panels

Pre-terminated HFO camera connector panel with built-in splice enclosure box provides easy and quick installation between HD camera system and terminal panel or rack. By combining the unit and frame, HFO camera connector panel enables a variety of layouts depending on the system design.

#### ■ COPS-F Series (SMPTE)

Model	Panel Size	HFO Connectors* (Assembly)
COPS-FF3	Wall Mount Type	2x FCFRA (FCS003A-FR)
COPS-FM3	3RU Height, W:197.6mm	2x FCMRA (FCS003A-MR)
COPS-FF2	Wall Mount Type	2x FCFRA (FCS003A-FR)
COPS-FM2	2RU Height, W:197.6mm	2x FCMRA (FCS003A-MR)
COPS3-FF3	Rack Mount Type	6x FCFRA (FCS003A-FR)
COPS3-FM3	3RU	6x FCMRA (FCS003A-MR)
COPS3-FF2	Rack Mount Type	6x FCFRA (FCS003A-FR)
COPS3-FM2	2RU	6x FCMRA (FCS003A-MR)

\* Each HFO connector is pre-terminated. (length: 0.3m)

\* TAJIMI compatible type (OC series) is also available. Please contact Canare for more information.

#### Key Features and Benefits

- Exclusive "5-directional Wiring"
- Convenient to build I/O interface between HD facilities and HD OB vans
- Variety of choice of 2RU/3RU and wall/rack mount
- Pre-terminated HFO connectors reduce installation time dramatically.
- Cost effective

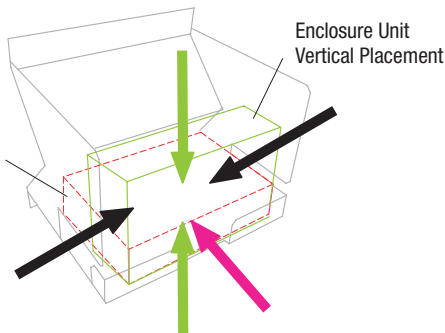

5 directions of cabling as indicated by colored arrows  
 — Vertical/Transverse placement  
 — Transverse placement  
 — Vertical placement

**5-directional Wiring**  
 JP Patent No.4388540

#### ■ Wiring Diagram

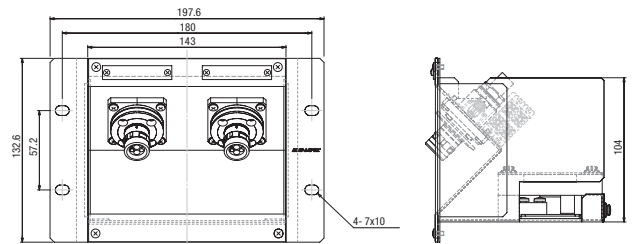
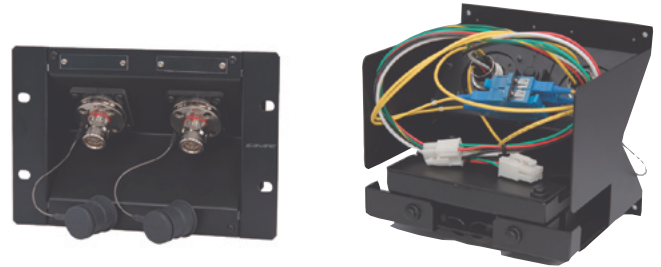
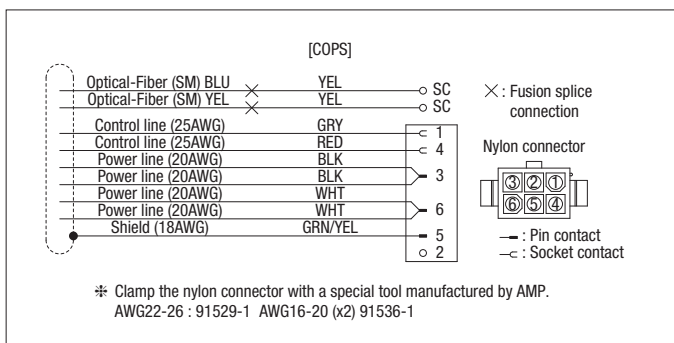

COPS-FF3

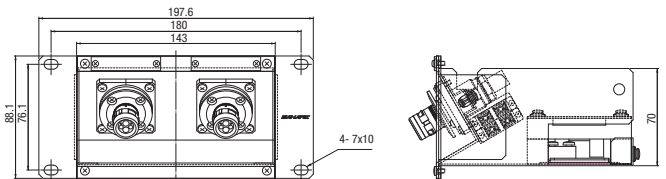

COPS-FF2

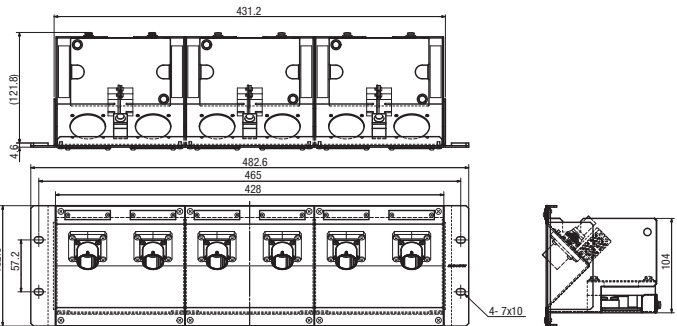

COPS3-FM3

#### Accessories:

Fiber-optic cable w/SC connector (2m), grounding cable, nylon connector, pin contact, socket contact, tie-band, fusion splice protection sleeve, splice holder, color-coded tube, mounting screw, laser warning label.

[NOTE] A separately available dedicated tool is required to assemble nylon connectors.

## Individual Units and Parts

Model	Panel Height	Description
COUS-FF3	3RU	Connector Unit w/ 2x FCFRA (FCS003A-FR)
COUS-FM3	3RU	Connector Unit w/ 2x FCMRA (FCS003A-MR)
COUS-FF2	2RU	Connector Unit w/ 2x FCFRA (FCS003A-FR)
COUS-FM2	2RU	Connector Unit w/ 2x FCMRA (FCS003A-MR)
COU-BP3	3RU	Blank Panel
COU-BP2	2RU	Blank Panel
COF-13	3RU	Frame for 1 Unit
COF-12	2RU	Frame for 1 Unit
COF-33	3RU	Frame for 3 Unit
COF-32	2RU	Frame for 3 Unit

\* Each HFO connector is pre-terminated. (length: 0.3m)

\* TAJIMI compatible type (OC series) is also available. Please contact Canare for more information.

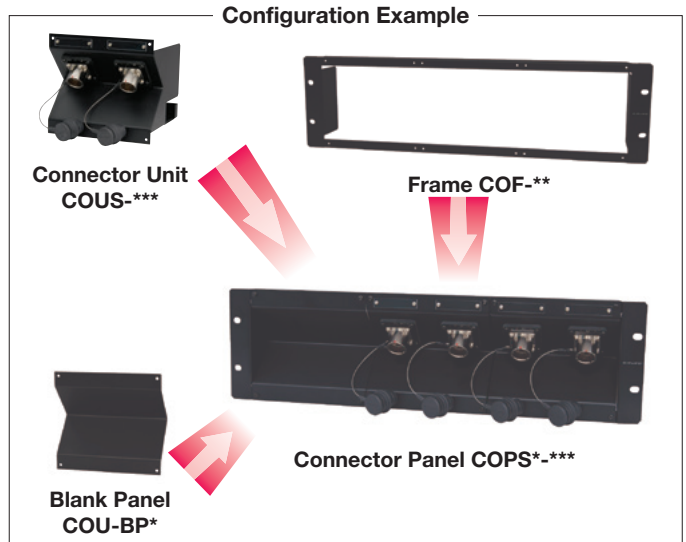

## <Example of Use>

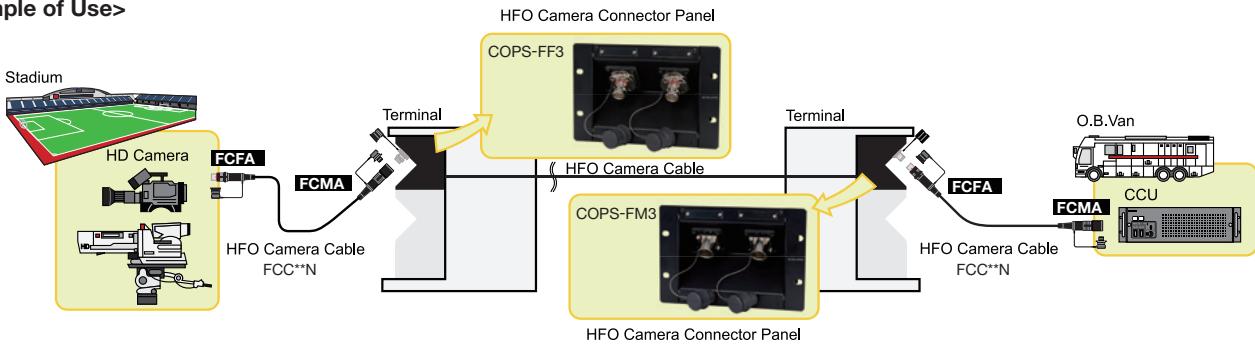

## Hybrid Fiber-optic Splice Enclosures

The fiber-optic splice enclosure was designed specifically for use with hybrid fiber-optic camera cables. The enclosure is used to protect fusion splice connection parts after installation.

Model	No. of cables	Fusion splice tray No.	Adapter	
			SC	Nylon connector
FCE-2	2	1	4	2
FCE-4	4	2	8	4
FCE-6	6	3	12	6

- The enclosure is designed specifically for the hybrid fiber-optic camera cable (LF-2SM9), making installation and operation very easy.
- The enclosure can be installed on walls or placed flat. Mounting bracket (connector protection cover) can be detached from the box when installing in limited space.
- The enclosure is designed with two configurations, the top-bottom split design (FCE-2, FCE-4) and the removable panel design (FCE-6). Both designs enable easy installation of cables.
- The connection with hybrid fiber-optic receptacle cable is done by use of connectors, thus enabling easy interchanging of lines after installation.
- The tension member is insulated from the chassis.

Note :  
The following special tools are required for installing the nylon connectors.  
Models: AMP91529-1 (26 to 22 AWG) and AMP91536-1 (20 to 16 AWG)

## Wiring Diagram (Canare standard)

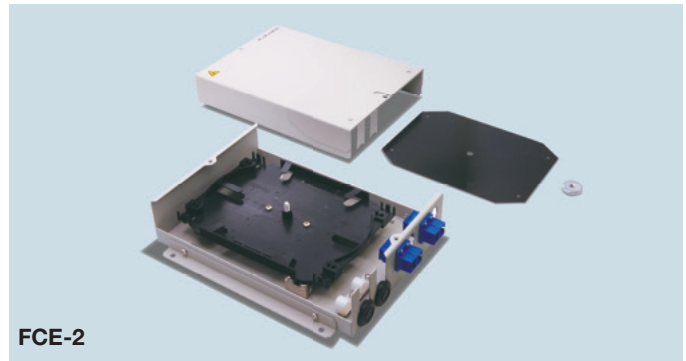
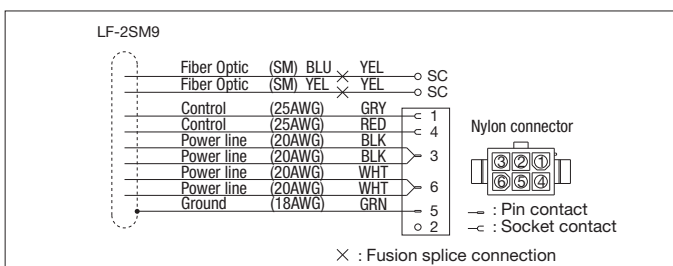

Accessories:  
Fiber-optic cable w/SC connector (2m), splice holder, fusion splice protection sleeve, nylon connector, pin contact, socket contact, tie band, grounding cable, color-coded tube.

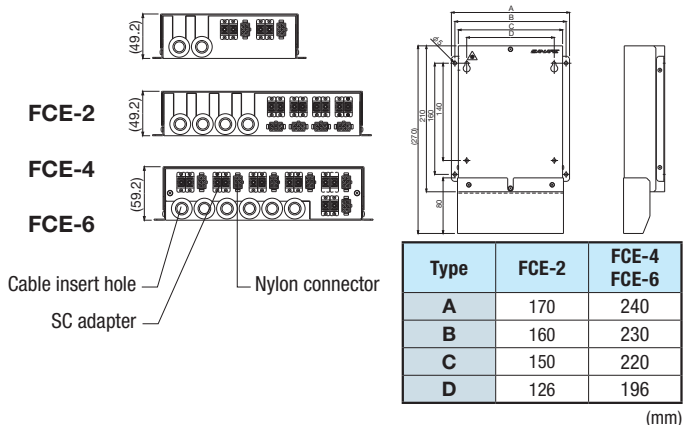

### Hybrid Fiber-Optic Camera Cable Checker

Canare Cable Checker allows fast, easy confirmation of HFO cables in the field. No heavy equipment to drag around. The compact design features a backlight digital display to measure optic loss/power and electrical continuity. Small and light, Canare Cable Checker helps make mobile installations smooth, secure and constant.

Kit Model	Individual Model	
	Measuring Unit	Loop-back Unit
<b>FCT-FCKIT</b>	FCT-FC	FCT-FCLB

\* TAJIMI compatible type (OC series) is also available. Please contact Canare for more information.

#### Key Features and Benefits

- Compact, hand-held design
- Measured optical loss and power in addition to electrical signals
- 2x AA, 20 hours battery life
- The kit includes a storage case, carrying cases, AA Batteries, and cleaning sticks

#### Specifications

Kit Model	FCT-FCKIT
Connector	SMPTE/ARIB (Canare FC Series)
LD	FP-LD
Wavelength	1310nm
Output Power	-2.5dBm
Sensitivity	-24 to -2dBm
Maximum Length	3.5km (Canare LF-2SM9N)
Optic Lines	Two Lines: Power and Loss
Copper Lines	Power, Control, and Shield: Connectivity
Battery/Life	2pcs of AA/ Approx. 20hours
Operating Temperature	-10 to 60°C
Dimensions	FCT-FC: 46x 46x 150mm FCT-FCLB: 46x 46x 65mm
Weight	FCT-FC: 380g FCT-FCLB: 170g
Accessories	Storage case, carrying cases, AA Batteries, and cleaning sticks

CE, FCC, FDA registered  
US Patent No.7113678  
JP Patent No.4155979



Carrying Cases



Storage Case

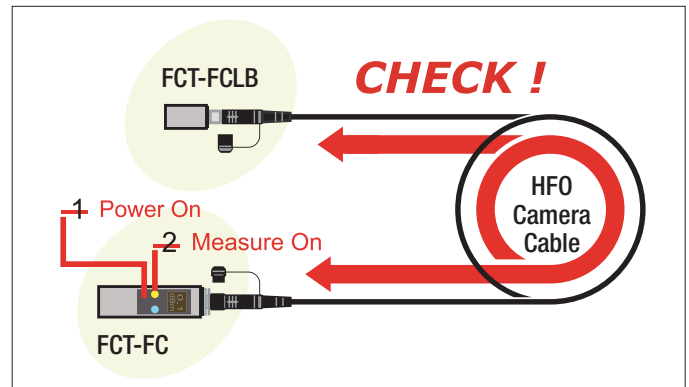

## Technical Note

### Maintaining Hybrid Fiber-Optic Camera Connectors

The connector sections to be cleaned are the key parts, including the tips and sides of ferrules, the interior walls of alignment sleeves and the interior and exterior of connector shells. Note that scratches and particles of foreign matter on the tip of the ferrule can have a disabling effect on fiber-optic transmission. The following procedures should be used when cleaning hybrid fiber-optic camera connectors.

- For Plugs, the interior surfaces of alignment sleeves and the tips of ferrules are to be cleaned with the non-alcohol treated cleaning stick using a gentle stroking action. Canare FCFA and FCFRA enhance easy cleaning procedure for its innovative alignment sleeve and insulator detachable design.

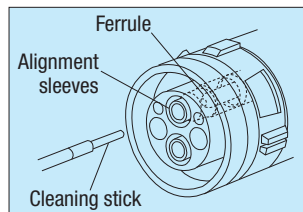

US Patent: No.7241055B2, JP Patent: No.4340186

- For Jacks, it is important to clean both the tips and sides of the completely protruding ferrules with the cleaning stick.
- Both the male and female connector shells tend to attract dust and metal particles, so it is important to clean both the insides and outsides using cotton gauze or similar material.



Before cleaning

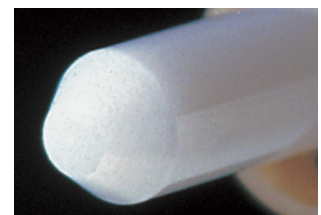

After cleaning

#### Cleaning Stick Model: CLETOP 2.5/2.0

- Compact and disposable
- Allows cleaning both the tips and sides of ferrules
- Manufactured by NTT-AT

Cleaning stick  
CLETOP 2.5/2.0



#### IBC Brand Cleaner M-20 Model: 14347 CLEANER

- Easy "one-push" cleaner
- Allows cleaning the tips of ferrules without removing alignment sleeve
- Manufactured by US Conec

IBC Brand Cleaner M-20  
14347 CLEANER





## Tactical Fiber-optic Cable

Particularly rugged multichannel fiber-optic cable designed for mobile applications.

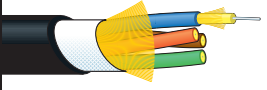
Type	Model	No. of ch.	Sales Units (m)	Nom. O.D. (mm)	Weight kg/100m	Tension Tolerance (N)	Strength Member	Min. Bend Radius	Temp. Range (deg C)	Fiber-optic Unit		
										Fiber	Attenuation	Unit O.D.
 Jacket color : black	LF-SM2T-4C	4	100 200 500	7.8	4.9	1400	Aramid yarn	Equal to Nom. O.D.	-55 to +85	SM 9/125 (low-water-peak)	1.6 dB/km @1310 nm	2.0 mm including aramid yarn

Jacket: TPU

### LF-SM2T-4C

- Heavy-duty and high flexibility
  - \* Crush resistance: 2,000 N/cm
  - \* Impact resistance: 300 impacts
  - \* Cycle flexing: 20,000 cycles
- Single-mode
- Color-coded breakout type unit
- Thermoplastic polyurethane jacket
- Aramid yarn strength member
- 4-channel cable best suited for Quad-link 3G-SDI signals.

### Cross Section

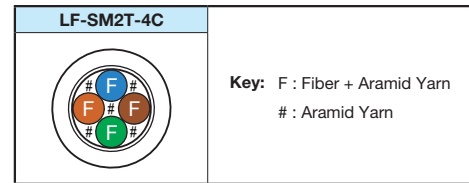

### Cable Assemblies

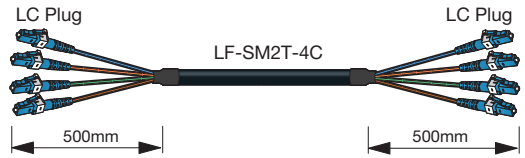
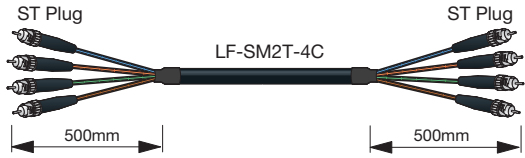
Type	Model	Length (m)
 Jacket color : black	4FS50T-SS	50
	4FS100T-SS	100
	4FS150T-SS	150
	4FS200T-SS	200
 Jacket color : black	4FS50T-LS	50
	4FS100T-LS	100
	4FS150T-LS	150
	4FS200T-LS	200
 Jacket color : black	4FS50T-ST	50
	4FS100T-ST	100
	4FS150T-ST	150
	4FS200T-ST	200

## Single-mode Fiber-optic Cables (Multichannel)

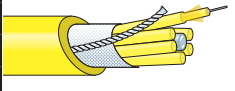
Type	Model	No. of Ch.	Sales Units (m)	Nom. O.D. (mm)	Weight kg/100m	Outer Jacket	Tension Tolerance (N)	Min. Bend Radius	Temp. Range (deg C)	Fiber-optic Unit		
										Fiber	Attenuation	Unit O.D.
 LF-SM2-6C Jacket color: yellow	LF-SM2-2C	2	Call	7.4	5.4	PVC	290	10 x Nom. O.D.	-40 to +75	SM 9/125 + Aramid yarn + PVC jacket	0.5 dB/km @1310nm	2.0 mm including aramid yarn
	LF-SM2-4C	4		7.4	5.5		290					
	LF-SM2-6C	6		9.0	7.3		300					
	LF-SM2-8C	8		10.0	10.4		780					
	LF-SM2-12C	12		12.8	14.2		780					
	LF-SM2-16C	16		14.7	16.3		780					
	LF-SM2-24C	24		15.0	18.3		780					

- Smooth PVC Jacket
- Including a central strength member and a rip cord.

### Fiber-optic Assemblies (Single/Dual Channel)

#### Single mode

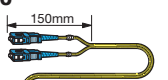
Type	Model	Length (m)
SC - SC 	FS3C002-S	0.2
	FS3C003-S	0.3
	FS3C005-S	0.5
	FS3C01-S	1.0
	FS3C015-S	1.5
	FS3C02-S	2.0
	FS3C03-S	3.0
	FS3C05-S	5.0
	FS3C10-S	10.0
	FS3C15-S	15.0
	FS3C20-S	20.0
FS3C30-S	30.0	
Jacket color: yellow		
SC - SC 	2FSZ3S02-S	2.0
	2FSZ3S03-S	3.0
	2FSZ3S05-S	5.0
Jacket color: yellow		

- Flexible cable with reliable bellcore boots
- UPC polishing; Return loss  $\geq 50$ dB for single mode and  $\geq 25$ dB for multi mode
- Transmission loss 0.5dB at  $\lambda = 1.31\mu\text{m}$  and 0.4dB at  $\lambda = 1.55\mu\text{m}$  for single mode
- Transmission loss 3.0dB at  $\lambda = 0.85\mu\text{m}$  and 1.0dB at  $\lambda = 1.30\mu\text{m}$  for multi mode

#### Multi mode

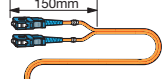
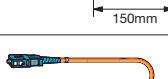
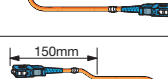
Type	Model	Length (m)
SC - SC G150/125 	FG53C02-S	2.0
	FG53C03-S	3.0
	FG53C05-S	5.0
Jacket color: orange		
SC - SC G150/125 	2FG5Z3S02-S	2.0
	2FG5Z3S03-S	3.0
	2FG5Z3S05-S	5.0
Jacket color: orange		
SC - SC G162.5/125 	FG63C02-S	2.0
	FG63C03-S	3.0
	FG63C05-S	5.0
Jacket color: orange		
SC - SC G162.5/125 	2FG6Z3S02-S	2.0
	2FG6Z3S03-S	3.0
	2FG6Z3S05-S	5.0
Jacket color: orange		

### Fiber-optic Assemblies (Multichannel Fantails)

#### Single mode

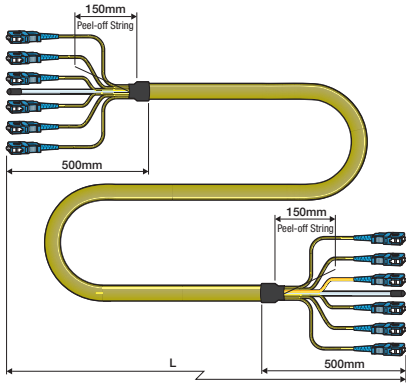
Type	Channel	Model	Length (m)	Fiber Optic Cable					
				Part Number	Unit O.D. (mm)	Nom. O.D. (mm)			
SC - SC 	2	2FS10-S	10	LF-SM2-2C	2	7.4			
		2FS20-S	20						
		2FS50-S	50						
	4	4FS10-S	10	LF-SM2-4C					
		4FS20-S	20						
		4FS50-S	50						
	6	6FS10-S	10	LF-SM2-6C					
		6FS20-S	20						
		6FS50-S	50						
	8	8FS10-S	10	LF-SM2-8C					
		8FS20-S	20						
		8FS50-S	50						
	12	12FS10-S	10	LF-SM2-12C					
		12FS20-S	20						
		12FS50-S	50						
	16	16FS10-S	10	LF-SM2-16C					
		16FS20-S	20						
		16FS50-S	50						
	24	24FS10-S	10	LF-SM2-24C					
		24FS20-S	20						
		24FS50-S	50						
	Jacket color: yellow								

- Flexible cable with reliable bellcore boots
- Adjustable fantail length with peel-off string
- UPC polishing; Return loss  $\geq 50$ dB for single mode
- Transmission loss 0.5dB at  $\lambda = 1.31\mu\text{m}$  and 0.4dB at  $\lambda = 1.55\mu\text{m}$

## 6-channel Fiber-optic Snakes

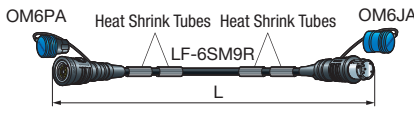
Type	Model	Length (m)
	OM6C10	10
	OM6C20	20
	OM6C25	25
	OM6C35	35
	OM6C50	50
	OM6C100	100
	OM6C150	150
	OM6C200	200

Jacket color : black

- Ruggedized multichannel fiber-optic assemblies with robust 6-fiber connector
- Single-mode, ITU-T G.657.A2 low bending loss and low water-peak fiber
- Abrasion-resistance cable jacket
- Tensile strength: 700 N or less
- Return loss: 45 dB or greater ( $\lambda = 1.3 \mu\text{m}$ )
- Insertion loss: 0.5 dB or greater ( $\lambda = 1.3 \mu\text{m}$ )
- 7-color connector rings included.
- Blue dust cap makes it easier to distinguish OM6 from HFO camera connectors that have similar appearance.



OM6PA



OM6JA



Color Rings

- \* Canare OM6 connectors are NOT compatible with other multichannel/hybrid fiber-optic connectors.
- \* IBC brand "one-push" cleaner M-20 is highly recommended for cleaning OM6 connectors. (see page 17, model: 14347 CLEANER)

## 6-channel Fiber-optic Fantails

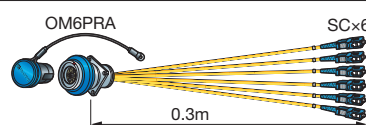
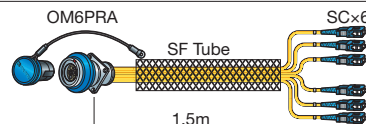
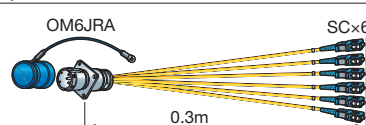
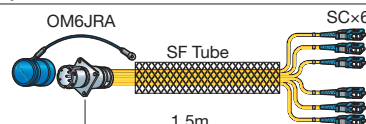
Type	Model	Length (m)
 <p>Jacket color : yellow IU-FCM-SET included</p>	OM6S003-PR	0.3
 <p>Jacket color : yellow IU-FCM-SET included</p>	OM6S015-PR	1.5
 <p>Jacket color : yellow IU-FCM-SET included</p>	OM6S003-JR	0.3
 <p>Jacket color : yellow IU-FCM-SET included</p>	OM6S015-JR	1.5

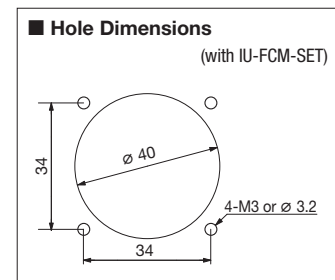

- OM6 receptacle with 6 SC single-mode fiber cord (2.0mm).
- Return loss: 45 dB or greater ( $\lambda = 1.3 \mu\text{m}$ )
- Insertion loss: 0.5 dB or greater ( $\lambda = 1.3 \mu\text{m}$ )
- Blue dust cap makes it easier to distinguish OM6 from HFO camera connectors that have similar appearance.

- \* Canare OM6 connectors are NOT compatible with other multichannel/hybrid fiber-optic connectors.
- \* IBC brand "one-push" cleaner M-20 is highly recommended for cleaning OM6 connectors. (see page 17, model: 14347 CLEANER)



### 3G Transmission Design

#### 3G-SDI Popularity

3G-SDI (3Gb/s Signal/Data Serial Interface) is a transmission format (1080p) that provides twice the data transmission capacity (bandwidth) of today's widely used HD-SDI (1080i), and its use has seen rapid expansion in recent years. The data format was standardized as SMPTE 424M in 2006, and was revised as the SMPTE ST 424 Standard in 2012, including a change in typical cable loss recommendations (from 20dB to 30dB). Dual-link 3G-SDI and Quad-link 3G-SDI provide reasonable solutions for meeting the production requirements of HDR HDTV, 2K/4K D-Cinema and UHD TV-1.

#### Signal Attenuation in 3G Transmission Lines

In order to keep overall transmission line attenuation below the 30dB loss budget, it is necessary to calculate attenuation amounts individually for each section in the system. In the system shown below, the losses occurring within each transmission line have been calculated and entered into a level diagram. From this it is possible to see the differences in transmission distances possible with HD-SDI and 3G-SDI when using a coaxial cable (L-7CHD). If this shows that attenuation will surpass the specified loss budget, then it will be necessary to change to cables with less attenuation,

#### SMPTE Requirements

Format	HD-SDI SMPTE ST 292	3G-SDI SMPTE ST 424	12G-SDI SMPTE ST 2082-1
Bit Rate	1.485 Gb/s	2.97 Gb/s	11.88 Gb/s
Impedance (Zo)	75Ω		
Cable Loss	20 dB @ 750 MHz (@ 742.5 MHz)	30 dB @ 1.5 GHz (@ 1.485 GHz)	40 dB @ 6 GHz (@ 5.94 GHz)
Return Loss	5 M-1.5 GHz	15 dB	15 dB
	1.5-3 GHz	-	10 dB
	3-6 GHz	-	7 dB
	6-12 GHz	-	4 dB

or to revise the circuit and/or equipment layout to compensate. It is also recommended that these calculations include a 2-3dB design margin.

#### 12G-SDI

In 2015, SMPTE released ST 2082-1 12G-SDI, a standard for UHD-SDI (4K 2160p), as the next-generation of the single-link SDI format. 12G-SDI makes possible transmission of as much as eight times the data volume of HD-SDI (2K 1080i), and as much as four times the data volume of 3G-SDI (2K 1080p) over a single coaxial cable. At the same time, high performance is also required of both cables and connectors (refer to the table above), and Canare has already commenced efforts to meet these requirements.

#### <System Example>

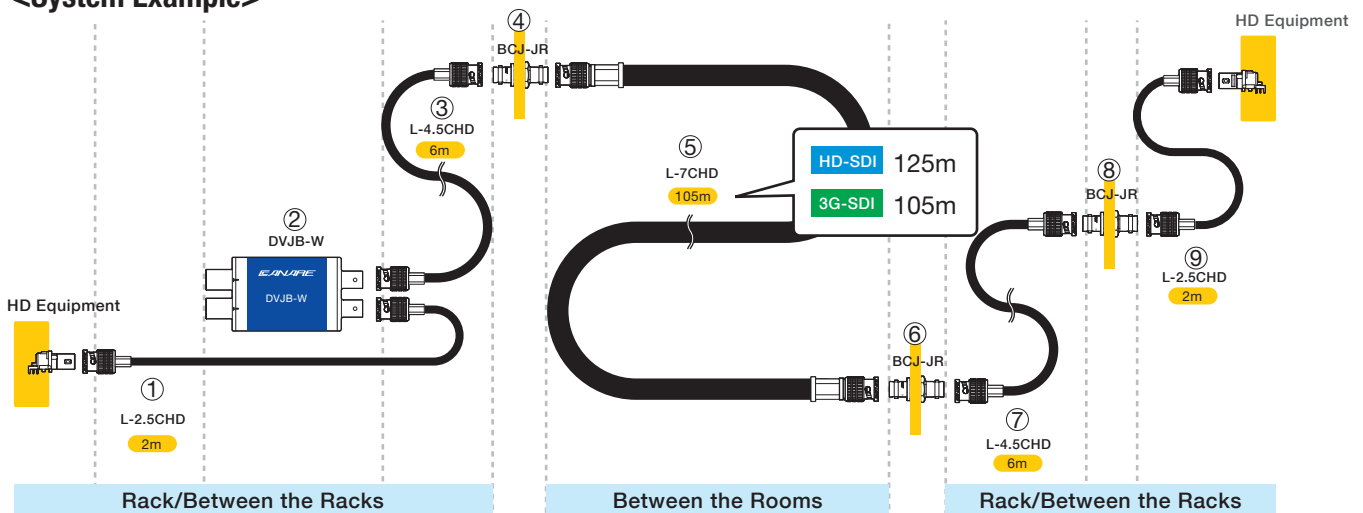

#### <Level Diagram>

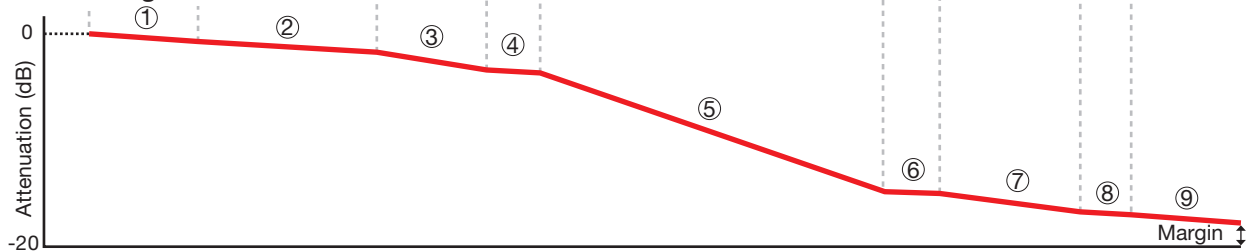

#### System Attenuation

Format	Connector/ Cable	① L-2.5CHD	② DVJB-W	③ L-4.5CHD	④ BCU-JR	⑤ L-7CHD	⑥ BCU-JR	⑦ L-4.5CHD	⑧ BCU-JR	⑨ L-2.5CHD	Sub Total	Margin	Total Amount
HD-SDI	m or pcs	2	1	6	1	125	1	6	1	2	17.6 dB	2.4 dB	20.0 dB
	Loss (dB/m)	0.3	0.9	0.2	0.2	0.1	0.2	0.2	0.2	0.3			
	Loss (total) (dB)	0.6	0.9	1.2	0.2	12.5	0.2	1.2	0.2	0.6			
3G-SDI	m or pcs	2	1	6	1	105	1	6	1	2	27.7 dB	2.3 dB	30.0 dB
	Loss (dB/m)	0.4	0.9	0.3	0.2	0.2	0.2	0.3	0.2	0.4			
	Loss (total) (dB)	0.8	0.9	1.8	0.2	21.0	0.2	1.8	0.2	0.8			

## 75Ω Active BNC Receptacles

Small BNC connector incorporates either a cable equalizer or a cable driver. Active BNC makes innovation in your 3G-SDI PC board layout.

Model	Description	Built-in IC
BCA-TL	TX, Right Angle	Cable Driver
BCA-RL	RX, Right Angle	Cable Equalizer
BCA-TS	TX, Straight	Cable Driver
BCA-RS	RX, Straight	Cable Equalizer

• Standard package (5pcs)

- BNC connector integrated with a cable equalizer or a cable driver, and yet keep the connector size to a minimum.
- Supports 3G-SDI, HD-SDI, SD-SDI and DVB-ASI
- Offers an excellent return loss performance without designing 75 ohm I/O block
- Simplifies PCB design process dramatically and will reduce entire development cost
- PCB space saving and help to downsize devices
- Easy to distinguish TX from RX by color-coded insulation

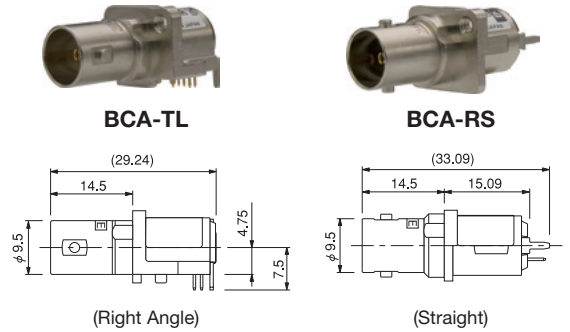
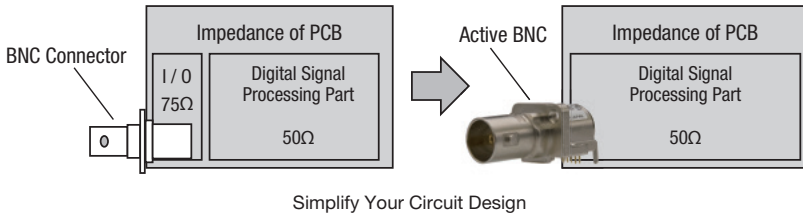

(Right Angle)

(Straight)

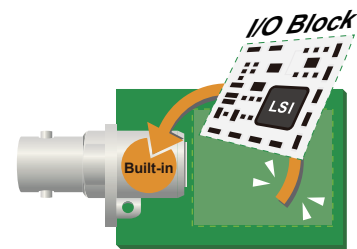

Space-saving

### Specifications

Model	TX BCA-TL, BCA-TS	RX BCA-RL, BCA-RS
Supply Voltage	DC 3.3V	
Current Consumption	50mA	70mA
Operating Temperature	-25°C to +85°C	
Output Signal Amplitude	800mVpp	—
Equalizing Cable Length	—	3G-SDI 120m w/L-5CFB
Compliant	SMPTE 424M, 292M, 259M, BTA S-004C, EN50083-9, RoHS	
Weight	Approx. 9.0g	

US Patent No.: 8251721 B2  
JP Patent No.: 4837715

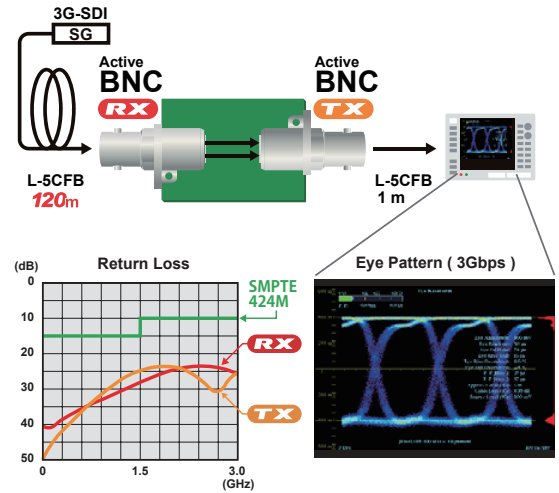

	BCA-TL	BCA-RL	BCA-TS	BCA-RS
<b>Panel Hole Dim.</b>	<p>t1.6 Screw: M2.6</p>		<p>t1.6 Screw: M2.6</p>	
<b>PCB Hole Dim.</b>	<p>t2.0 (TOP VIEW)</p> <p>Pin 8 5 0 0 0 0 1234 1: GND 2: SDI+ 3: SDI- 4: Vcc 5: SD/HD 7: — 8: ENABLE</p>	<p>t2.0 (TOP VIEW)</p> <p>Pin 1234 0 0 0 0 1: GND 2: SDO- 3: SDO+ 4: Vcc</p>	<p>t2.0 (TOP VIEW)</p> <p>Pin 4321 0 0 0 0 5 8 1: GND 2: SDI+ 3: SDI- 4: Vcc 5: SD/HD 6: — 7: — 8: ENABLE</p>	<p>t2.0 (TOP VIEW)</p> <p>Pin 4321 0 0 0 0 1: GND 2: SDO- 3: SDO+ 4: Vcc</p>

Note: The darker shaded area will come into contact with the connector body.

### 75Ω DIN1.0/2.3 Connectors

Mini coax connectors IEC61169-29 and DIN 47 297 compatible.

#### DCP-C Series (Crimp Plugs)

VSWR 1.2 @ 3GHz

Model	Suitable Cable		Center Pin	Sleeve	Boot	Die Set
	Canare	Others				
DCP-C25HD	L-2.5CHD, L-2.5CHLT	1855A, VDM230	BN1148	BN7136	—	TCD-D253F
DCP-C3F	L-3CFB	—	BN1148	BN7003A	—	TCD-D253F
DCP-C4F	L-4CHD, L-4CFB	1505A, VPM2000	BN1158	BN7015A	—	TCD-D534F
DCP-C53	L-4.5CHD	1694A, VSD2001	BN1157	BN7138	—	TCD-D534F

•Standard package (20pcs/100pcs)

- Our unique ball-locking mechanism offers smooth and reliable mating.
- Canare crimp design ensures quick and reliable installation.
- Elongated body design enables stable finger grip.
- Return loss: 20 dB or greater up to 3GHz
- Extraction tool : BET-DIN (see page 38)

US Patent No.: 8764473 B2

Be sure to use Canare crimping tool for installing connectors on cables



DCP-C25HD

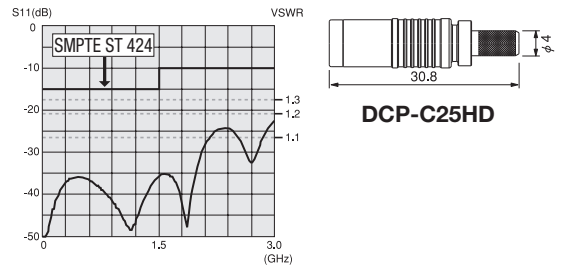

Return Loss for DCP-C25HD

#### PCB Mount Receptacles

VSWR 1.2 @ 3GHz

Model	Description	Nut Driver Bit
DCJ-LR	Right Angle	NDT-DIN
DCJ-LR/1	Right Angle, Long type	
DCJ-FEM	Edge Mount	

•Standard package (20 pcs)

- Compact design ideal for high density mounting and downsizing devices.
- Combination of DCJ-LR/1 and DCJ-FEM will be effective for staggered arrangement.
- Return loss: 20 dB or greater up to 3 GHz.

Note: Nut driver bit NDT-DIN is required.

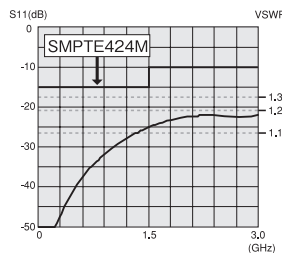

Return Loss for DCJ-LR



DCJ-LR

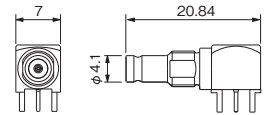

DCJ-LR/1

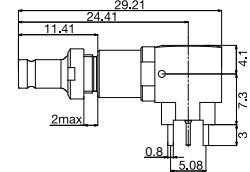

DCJ-FEM

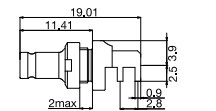

#### Adapters

VSWR 1.1 @ 3GHz

Model	Description	Panel Mount	Nut Driver Bit
DCJ-JR	Jack to Jack	Yes	NDT-DIN
BCJ-DCJ	BNC Jack to DIN1.0/2.3 Jack	Yes	N/A
BCE-DCJ	BNC Plug to DIN Jack	No	N/A

•Standard package (20 pcs)

- Return loss: 26 dB or greater up to 3 GHz.

Note: Nut driver bit NDT-DIN is required for DCJ-JR



DCJ-JR

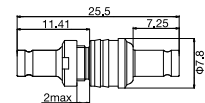

BCJ-DCJ

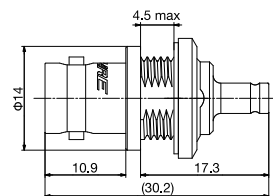

BCE-DCJ

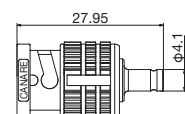

#### <Panel Hole Dim.>

#### <PCB Hole Dim.>

Model	Panel Hole Dim.	PCB Hole Dim.
DCJ-LR DCJ-LR/1 DCJ-FEM DCJ-JR		
BCJ-DCJ		

#### Nut Driver Bit

Model	Description
NDT-DIN	6.35mm (1/4") hex shank



NDT-DIN



## 4K-DIN Coax Connectors

Canare unique “4K-DIN” allows you to connect or disconnect 4 of 3G-SDI signals in one easy step.

### ■ Crimp Plugs

Model	Suitable Cable	Die Set	Description
<b>MDM-V4C25HW</b>	V4-2.5CHW	TCD-D253F	Male
<b>MDF-V4C25HW</b>	V4-2.5CHW	TCD-D253F	Female

### ■ Flush-mount Receptacle

Model	Description
<b>MDF-V4JRU</b>	Jack to Jack

- 75Ω 4-channel coax connector with push-pull locking mechanism.
- Compact, solid, and lightweight nylon resin (PA 66) body
- Return loss: 20 dB @ 3 GHz
- MDF-V4JRU accepts MDM-V4C25HW and also DIN 1.0/2.3 plugs.

\* Replacement crimp units also available:  
DCP-C25HW-ML for MDM  
DCJ-C25HW-ML for MDF

#### <Connection Example>

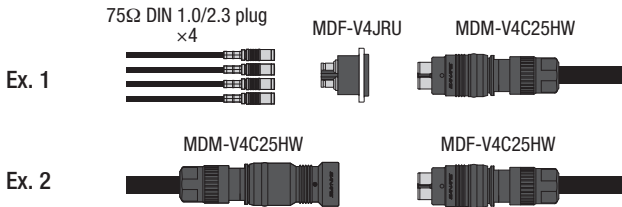

Be sure to use the Canare crimping tool for installing connectors on cables.



**MDM-V4C25HW**

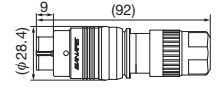

**MDF-V4C25HW**

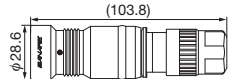

**MDF-V4JRU**

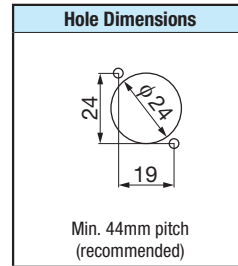
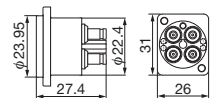

## 75Ω Multi-pin Coax Connectors

Handles five 75Ω coaxial connections.

Model	Suitable Cable	Die Set	Description
<b>MCM-V5C3</b>	V5-3C	TCD-35CA	Plug
<b>MCF-V5C3</b>	V5-3C, L-3C2V, L-3C2VS	TCD-35CA	Receptacle

Model	Description
<b>DCM01</b>	Dust Cap for MCM-V5C3
<b>DCF01</b>	Dust Cap for MCF-V5C3

- 1.2 or less VSWR up to 1.5GHz.
- Crimp system ensures quick and reliable installation.

\* Replacement unit also available. MCM-V5C3: BN9078A MCF-V5C3: BN9079B

Be sure to use the Canare crimping tool for installing connectors on cables.



**MCM-V5C3**



**MCF-V5C3**

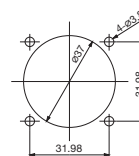
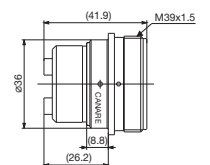
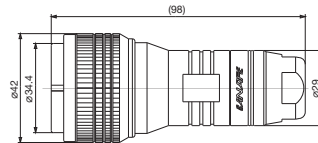

Panel Hole Dimensions  
(Mounting screw M3 x 4 pcs)

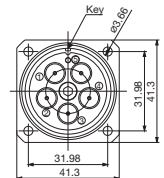

**Replacement Unit BN9078A**



**Replacement Unit BN9079B**

### 75Ω BNC Crimp Plugs

Canare True 75 Ω BNC Connectors has been widely used in the world with quick and reliable crimp design, and outstanding performance. The high-end model BCP-B series are specially designed for particular coax cables, and minimize return loss at 3 GHz.

#### ■ BCP-B Series

VSWR 1.1 @ 3GHz

Model	Suitable Cable		Center Pin	Sleeve	Boot	Die Set
	Canare	Others				
★ BCP-B25HD	L-2.5CHD, L-2.5CHLT	VDM230	B11015E	BN7129	CB02	TCD-35CA
★ BCP-B25HW	V4-2.5CHW	—	B11015E	BN7143	CB02	TCD-35CA
★ BCP-B26	—	1855A, 1855P	B11014E	BN7029C	CB02	TCD-35CA
★ BCP-B28	—	1855ENH, HD PRO 0.6/2.8 AF	B11015E	BN7052A	CB02	TCD-35CA
★ BCP-B3F	L-3CFB, V*-3CFB	—	B11015E	BN7003A	CB03	TCD-35CA
★ BCP-B31F	L-3CFW, V*-3CFW	—	B11015E	BN7015A	CB04	TCD-4CA, TCD-451CA
★ BCP-B4F	L-4CHD, L-4CFB, V*-4CFB	1505A, 1505ANH, VPM2000, HD PRO 0.8/3.7 AF	B11016E	BN7015A	CB04	TCD-4CA, TCD-451CA
★ BCP-B45HW	L-4.5CHWS	1694F	B11020D	BN7016	CB05A	TCD-35CA
★ BCP-B53	L-4.5CHD	1694A	B11020D	BN7046	CB05A	TCD-35CA
★ BCP-B56	—	HD PRO 1.0/4.8 AF	B11020D	BN7046	CB05A	TCD-35CA
★ BCP-B5F	L-5CFB, V*-5CFB	—	B11020D	B75004A	CB05A	TCD-5CF, TCD-55FA
★ BCP-B51F	L-5CFW, V*-5CFW	—	B11020D	B75004A	CB05A	TCD-5CF, TCD-55FA

• Standard package (20pcs/100pcs)



BCP-B5F

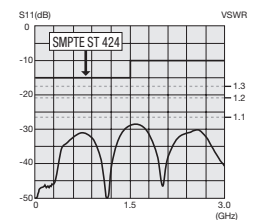

Return loss for BCP-B53

#### ■ BCP-A Series

VSWR 1.1 @ 2GHz, VSWR 1.2 @ 3GHz(\*1)

Model	Suitable Cable		Center Pin	Sleeve	Boot	Die Set
	Canare	Others				
★ BCP-A25	L-2.5C2V	—	BN1018A	BN7029C	CB02	TCD-35CA
★ BCP-A25F	L-2.5CFB	1855A, 8218, 1417B, 1418B	B11014E	BN7029C	CB02	TCD-35CA
★ BCP-A3	L-3C2VS, L-3C2V, V*-3C	—	B11014E	BN7003A	CB03	TCD-35CA
★ BCP-A31	L-3C2W	—	B11014E	BN7011	CB04	TCD-31C
★ BCP-A32	—	1506A, 1824A, 1825A, 1826A, 643948	B11016E	BN7026A	CB03	TCD-35CA
★ BCP-A3F	L-3CFB, V*-3CFB	—	B11015E	BN7003A	CB03	TCD-35CA
★ BCP-A4	LV-61S	8241, 8279, RG-59B/U	B11015E	BN7015A	CB04	TCD-4CA, TCD-451CA
★ BCP-A42	—	1505F	B11016E	BN7011	CB04	TCD-31C
★ BCP-A4F	L-4CHD, L-4CFB, V*-4CFB	1505A, 1505ANH, 8212, 8241F, 9167, 9259, 9659, VPM2000, HD PRO 0.8/3.7 AF	B11016E	BN7015A	CB04	TCD-4CA, TCD-451CA
★ BCP-A5	L-5C2VS, L-5C2V, V*-5C	—	B11016E	BN7016	CB05A	TCD-35CA
★ BCP-A52	L-5C2W	—	B11016E	BN7014	—	TCD-451CA
★ BCP-A55	—	1695A, VSD2001TS	B11020D	BN7045A	CB04	TCD-35CA
★ BCP-A5F	L-5CFB, V*-5CFB	—	B11020D	B75004A	CB05A	TCD-35CA
★ BCP-A77	LV-77S	8281F	B11016E	B75004A	CB05A	TCD-5CF-TCD-55FA
★ BCP-VA3	V*-3C	—	B11014E	BN7052A	CB03	TCD-35CA
★ BCP-VA5	V*-5C	—	B11016E	BN7045A	CB05A	TCD-35CA

• Standard package (20pcs/100pcs).

Note: Suitable die set for BCP-A5F is TCD-35CA; do not use TCD-5CF/TCD-55FA for BCP-A5F.

\*1: Excluding BCP-A25, BCP-A25F, BCP-A4



BCP-A3

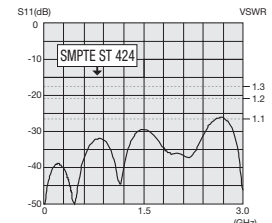

Return loss for BCP-A3

#### ■ BCP-C Series

VSWR 1.1 @ 2GHz (\*2)

Model	Suitable Cable		Center Pin	Sleeve	Boot	Die Set
	Canare	Others				
★ BCP-C1	L-1.5C2VS, V*-1.5C	83264, 83267	Solder	BN7022	CB01	TCD-1DB
★ BCP-C5HD	L-5CHD	—	BN1139	B75004A	CB05A	TCD-5HD
★ BCP-C6HD	L-6CHD	—	BN1083A	BN7074A	—	TCD-67HD
★ BCP-C71A	—	7731A, 9064, 9292, 1617A, 9011	BN1043A	BN7021A	—	TCD-7CA
★ BCP-C7FA	L-7CFB	—	BN1012B	BN7021A	—	TCD-7CA
★ BCP-C7HD	L-7CHD	—	BN1082A	BN7021A	—	TCD-67HD

• Standard package (20pcs/100pcs).

\*2: Excluding BCP-C1



BCP-C6HD

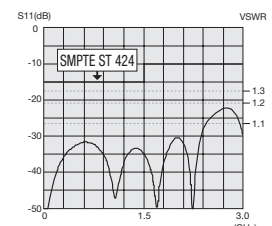

Return loss for BCP-C6HD

- Canare crimp design ensures quick and reliable installation.
- Gold plated "snap locks" center pin and beryllium copper outer contact.
- Elongated body design enables stable finger grip (excluding BCP-C1).
- Position mark on the BCP-B/A series body makes it easier to check if the connector is locked.

Note: Die set for BCP-A5F is TCD-35CA

Be sure to use the Canare crimping tool for installing connectors on cables.

75 Ω BNC Crimp Plugs (Right Angle Type)

■ BCP-LC Series

VSWR 1.1@ 2GHz

Model	Suitable Cable		Center Pin	Sleeve	Boot	Die Set
	Canare	Others				
BCP-LC3	L-3C2VS, L-3C2V, V*-3C	—	B11014E	BN7003A	—	TCD-35CA
BCP-LC3F	L-3CFB, V*-3CFB	—	B11015E	BN7003A	—	TCD-35CA
BCP-LC5	L-5C2VS, L-5C2V, V*-5C	—	B11016E	BN7016	—	TCD-35CA
BCP-LC5F	L-5CFB, V*-5CFB	—	B11020D	B75004A	—	TCD-5CF, TCD-55FA

• Standard package (20pcs)

- Canare crimp design ensures quick and reliable installation.
- Gold plated “snap locks” center pin and beryllium copper outer contact.

Be sure to use the Canare crimping tool for installing connectors on cables.



BCP-LC3

75 Ω Slim BNC Crimp Plugs

■ MBCP-C Series

VSWR 1.1@ 1.5GHz

Model	Suitable Cable		Center Pin	Sleeve	Boot	Die Set
	Canare	Others				
MBCP-C25F	L-2.5CFB	1855A, 8218, 1417B, 1418B	B11014E	BN7029C	—	TCD-35CA
MBCP-C3F	L-3CFB, V*-3CFB	—	B11015E	BN7003A	CB24	TCD-35CA
MBCP-C4	LV-61S	8241, 8279, RG-59B/U	B11015E	BN7015A	CB25	TCD-4CA, TCD-451CA
MBCP-C4F	L-4CFB, V*-4CFB	1505A, 1505ANH, 8212, 8241F, 9167, 9259	B11016E	BN7015A	CB25	TCD-4CA, TCD-451CA
MBCP-C53	L-4.5CHD	1694A, 9066, 9116, 9118, 9248	B11020D	BN7046	CB26	TCD-35CA
MBCP-C5F	L-5CFB, V*-5CFB	—	B11020D	B75004A	CB26	TCD-5CF, TCD-55FA

• Standard package (20pcs/100pcs)

- Slim design: OD 12 mm
- Compatible with 75 Ω BNC receptacles.
- Canare crimp design ensures quick and reliable installation.
- Gold plated “snap locks” center pin and beryllium copper outer contact.

Be sure to use Canare crimping tool for installing connectors on cables.

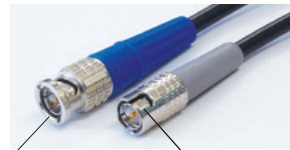

Conventional BNC Plug

Slim BNC Plug



MBCP-C3F

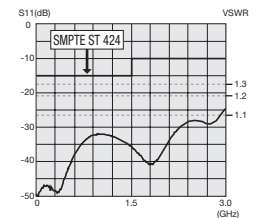
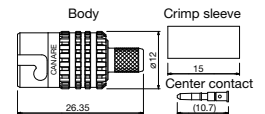

Return loss for MBCP-C3F

Technical Note

Voltage Standing-wave Ratio (VSWR) and Return Loss

Terminating the receiving end of a limited length coaxial cable using a resistance value not equal to its characteristic impedance creates a reflected wave that returns back down the cable to the sending end. The result is interference developing between the travelling wave and the return wave which results in a standing wave that causes voltage levels to fluctuate. The degree to which terminating resistance matches the characteristic impedance is indicated using the VSWR or voltage standing-wave ratio standard shown in Fig. 1. Going hand in hand with the VSWR ratio is the return loss factor which measures the size of the reflected wave current in relation to the travelling wave current. (See Fig. 2)

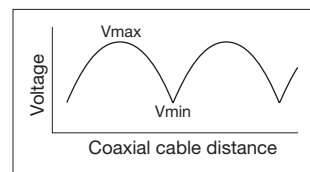

Fig. 1 Voltage Distribution Over Coaxial Cable

VSWR	Return Loss (dB)
2	9.5
1.5	14
1.2	20
1.1	26
1.05	32
1.02	40
1.01	46.1

Fig. 2 VSWR to Return Loss Conversion Table



### 75Ω BNC Solder Plugs

#### ■ BCP-H Series

VSWR 1.1@ 1GHz

Model	Suitable Cable	
	Canare	Others
BCP-H3B	L-3C2VS, L-3C2V, L-3CFB	—
BCP-H31F	L-3CFW	—
BCP-H45HW	L-4.5CHWS	1694F
BCP-H5B	L-5C2VS, L-5C2V, L-5CFB	—
BCP-H51F	L-5CFW, L-5CFB	—
BCP-H5/1	L-3C2VS, L-3C2V, L-3CFB	—
	L-5C2VS, L-5C2V, L-5CFB	

• Standard package (20pcs)

- The tubular (ferrule) section is silver plated to make soldering easier.
- Cable stripper TS100E can be used. (Excluding BCP-H31F, BCP-H51F)



BCP-H3B

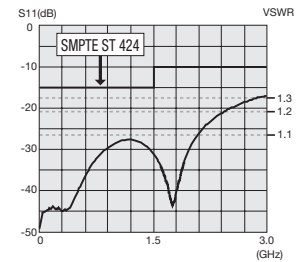

Return loss for BCP-H3B

### 75Ω BNC Jack Plug

Model	Suitable Cable	Boot	Die Set
BCJ-C4	RG-59 B/U, LV-61S, Belden 8241, 8279, 88241	CB25	TCD-4CA TCD-451CA

• Standard package (20pcs)

- 1.1 or less VSWR up to 1.5GHz, 1.2 or less up to 2.4GHz.
- Beryllium copper (gold plated) is used on the center contact for its superior spring characteristics. (Center contact: solder)

Be sure to use the Canare crimping tool for installing connectors on cables.



BCJ-C4

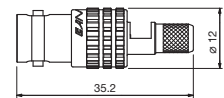

BCJ-C4

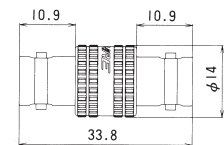

BCJ-J

### 75Ω BNC Extension Adapter

Model	Description
BCJ-J	Jack to Jack

• Standard package (20pcs/100pcs)

- Beryllium copper is used on the center contact for its superior spring characteristics.
- 1.1 or less VSWR up to 2GHz. <Fig. 1>



BCJ-J

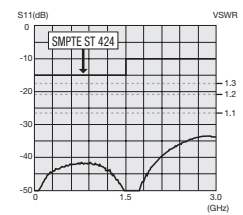

Fig.1 Return loss for BCJ-J

### 75Ω BNC Termination Plugs

Designed for true 75Ω termination

Model	Description
BCP-TB	True 75Ω Termination
BCP-TB-CH	True 75Ω Termination with String

• Standard package (20pcs/100pcs)

- Includes 1/4 watt resistance.
- 1.1 or less VSWR up to 3GHz. <Fig. 2>



BCP-TB

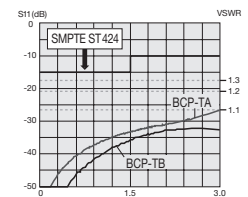

Fig.2 Return loss for BCP-TB and previous model BCP-TA

### Connector Boots

#### ■ CB0x Series

Our best selling connector boots for Canare BNC, TNC crimp plugs.

Model	Colors Available	BCP-xx	BP-xx	TNP-xx
CB01	BLK, BLU, GRN, RED, YEL, WHT	C1		
CB02		B25HD, B25HW, B26, B28, A25, A25F		
CB03	BLK, BLU, BRN, GRN, GRY,	B3F, B31F, A3, A32, A3F, VA3	C3, C4	C3, C4
CB04	ORN, PPL, RED, YEL, WHT	B4F, A31, A4, A42, A4F, A55	C31	C31
CB05A		B53, B56, B5F, B51F, A5, A5F, A77, VA5, C5HD	C5, C5FA	C5

#### ■ CB2x Series

Thinner type of CB0x series. Best fit for Canare Slim BNC, RCA, and F crimp plugs.

Model	Colors Available	Typical Connectors		
		MBCP-xx	RCAP-xx	FP-xx
CB24		C3F	C3A, C3F	C3, C3F
CB25	BLK, BLU, GRN, RED, YEL, WHT	C4, C4F	C3GS, C4A, C4F	C31, C4, C4F
CB26		C5F	C53, C5A, C5F	C5, C53A, C5F

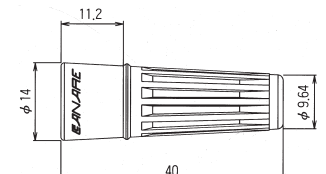

CB03, CB04, CB05A

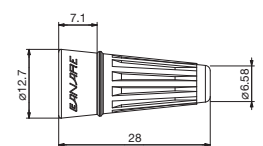

CB01, CB02

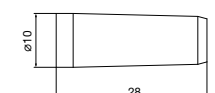

CB24, CB25, CB26

## 75Ω BNC Receptacles

BNC Receptacles emphasizing true 75Ω impedance.

### Standoff Receptacles

Model	Description	Suitable Cable	Die Set
BCJ-R	Jack to Solder	—	—
BCJ-R/1	Jack to Solder w/Ground Lug	—	—
BCJ-FC1	Panel Jack (1/2")	1.5C-2V	TCD-1DB
BCJ-FC1-7/16	Panel Jack (7/16")		
BCJ-JR	Jack to Jack	—	—

•Standard package (20pcs/100pcs)

### Flush-mount Receptacles

Model	Description	Flange Type	Suitable Cable	Die Set
BCJ-RU	Jack to Solder	ITT XLR-F77	—	—
BCJ-RUD		Neutrik D	1.5C-2V	TCD-1DB
BCJ-RUDB		Neutrik D (Black)	—	—
BCJ-RUC1	Panel Jack	ITT XLR-F77	—	—
BCJ-JRU	Jack to Jack	ITT XLR-F77	—	—
BCJ-JRUD		Neutrik D	—	—
BCJ-JRUDB		Neutrik D (Black)	—	—

•Standard package : 20pcs

- VSWR 1.1 @ 2GHz (Panel Jack: 1.1 @ 1GHz)
- Gold plated beryllium copper center contact
- Flush-mount receptacle prevents damage on the jack.

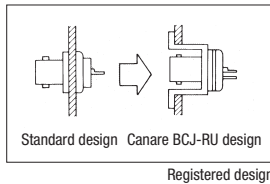

### Panel Hole Dimensions

BCJ-R	★BCJ-R/1 ★BCJ-JR	BCJ-FC1	★BCJ-FC1-7/16	BCJ-RUC1 BCJ-RU BCJ-JRU	BCJ-RUD BCJ-RUDB BCJ-JRUD BCJ-JRUDB

★ Indicate connectors that accept insulation bushing. Mounting hole for insulation bushing IU 7/16 should be adopted.

### Insulation Bushing

Model	Description
IU-7/16	ABS plastic

•Standard package: 20pcs

- Insulate a connector from a panel.
- 5 colors available (white, black, blue, green, red, or yellow)

**Note:** Please remove washers from a connector before using IU-7/16.

Mountable panel thickness:

1.2~1.5mm: BCJ-FPLVA, BCJ-FPLHA, BCJ-R/1

1.2~3.0mm: BCJ-FPC, BCJ-FPC02, BCJ-JR, BCJ-FPLV01



BCJ-R/1

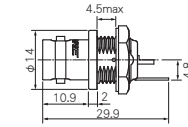

BCJ-R/1

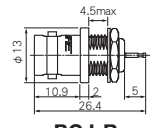

BCJ-R



BCJ-FC1-7/16

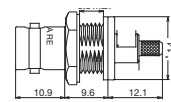

BCJ-FC1-7/16

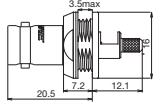

BCJ-FC1



BCJ-JR

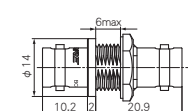

BCJ-JR

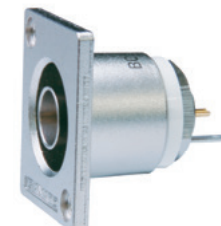

BCJ-RU

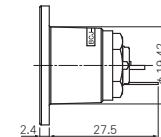

BCJ-RU



BCJ-RUC1

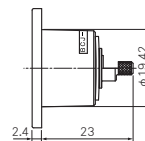

BCJ-RUC1



BCJ-JRU

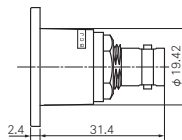

BCJ-JRU



BCJ-RUD

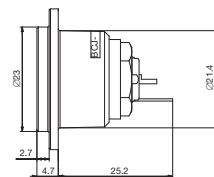

BCJ-RUD

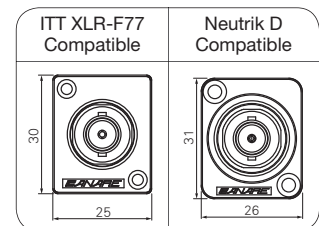

IU-7/16



Panel Hole Dimensions

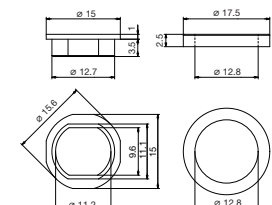

### 75Ω BNC PCB Mount Receptacles (Screw Type)

#### BCJ-BP Series

Model	Description	Stud Position	Panel Mount	Standard Package
BCJ-BPLHA	Right Angle	Horizontal	Front: M2.6 screw	20 pcs/100pcs
BCJ-BPLH2PA	Right Angle, Dual Jack			10 pcs
BCJ-BPLH3PA	Right Angle, Triple Jack			10 pcs
BCJ-BPC2P	Straight, Dual Jack	—		10pcs/100pcs

\* Screws are not included.

#### Key Features and Benefits

- True 75Ω PC board mount receptacle.
- VSWR 1.1 or less up to 1.5GHz, 1.2 or less up to 3GHz.  
(1.1 or less up to 1GHz, 1.2 or less up to 2.5GHz for BCJ-BPC2P)
- Gold plated beryllium copper center contact.
- Can be fixed on the PC board with M2.6 screw for efficient soldering.  
(excluding BCJ-BPC2P)
- Space-saving design allows high-density mounting.
- Eliminates wiring material and cost.

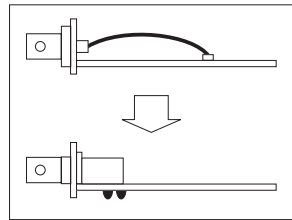

Note: Any cleaning solvents cannot be used. This leads to insulation problems.  
Insulation material: m-PPO (m-PPE)



BCJ-BPLHA BCJ-BPLH2PA BCJ-BPLH3PA

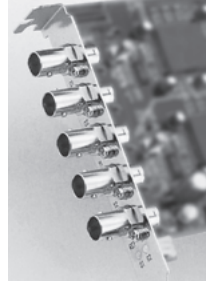

BCJ-BPLHA

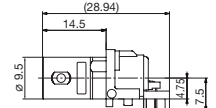
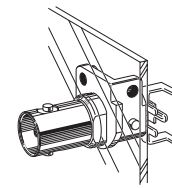

BCJ-BPLHA

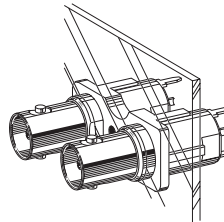

BCJ-BPC2P

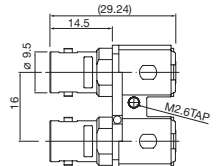

BCJ-BPLH2PA

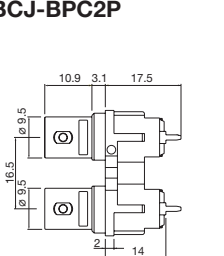

BCJ-BPC2P

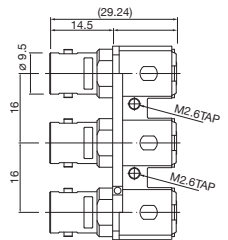

BCJ-BPLH3PA

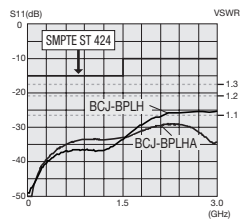

Return loss for BCJ-BPLH, BCJ-BPLHA

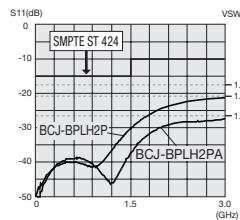

Return loss for BCJ-BPLH2P, BCJ-BPLH2PA

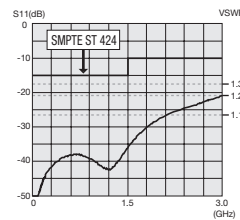

Return loss for BCJ-BPC2P

Comparison with the previous model

	BCJ-BPLHA	BCJ-BPLH2PA	BCJ-BPLH3PA	BCJ-BPC2P
Panel Hole Dim.	<p>Screw: M2.6 t1.6</p>	<p>Screw: M2.6 t1.6</p>	<p>Screw: M2.6 t1.6</p>	<p>Screw: M2.6 t1.2</p>
PCB Hole Dim.	<p>t2.0 (BOTTOM VIEW)</p>	<p>t2.0 (BOTTOM VIEW)</p>	<p>t2.0 (BOTTOM VIEW)</p>	<p>t1.6 (BOTTOM VIEW)</p>





### BNC Dust Caps

Model	Description
BCJ-DC	Polyethylene (Black)
BCJ-DC-CH	Polyethylene (Black) with string

•Standard package (20pcs/100pcs)

- Protects unused BNC receptacles from dirt and dust.



BCJ-DC

### BNC - RCA Adapter

Model	Description
BCP-RCAJ	RCA Jack (F) to BNC Plug (M)
BCJ-RCAP	BNC Jack (F) to RCA Plug (M)

•Standard package (1pc)

- Gold plated center contact
- Secure finger grip and reliable mating



BCP-RCAJ



BCJ-RCAP

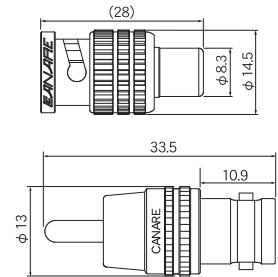

### 75Ω N Solder Plug

Model	Suitable Cable
NCP-H8HD	L-8CHD

•Standard package (1pc)

- Gold plating on the contact pin prevents deterioration, even after years of use.
- 1.1 or less VSWR up to 2GHz. <Fig. 3>
- Solder type

Tools required: 17mm and 21mm wrenches

Caution: The connecting section of the N connector uses a shape that conforms to the IEC169-16's 75Ω impedance standard. Note that the 50Ω N and other connectors that do not conform to this specification cannot be connected.



NCP-H8HD

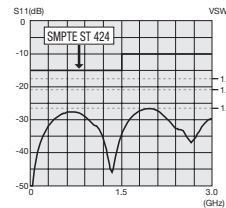
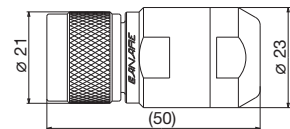

Fig.3 Return loss for NCP-H8HD

### 75Ω N to BNC Adapter

Model	Description
NCJ-BCJR	N (F) - BNC (F)

•Standard package (1pc)

- Beryllium copper (gold plated) is used on the center contact for its superior spring characteristics.
- 1.1 or less VSWR up to 2GHz. <Fig. 4>
- Panel mountable as well. For isolation from the panel, use Canare isolation bushing IU-7/16.(See page 33)



NCJ-BCJR

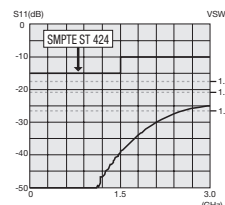
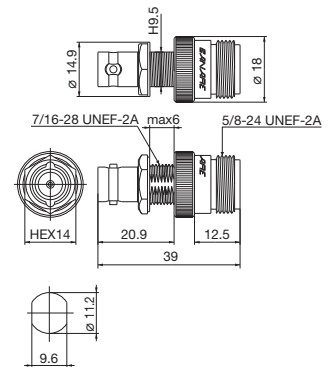

Fig.4 Return loss for NCJ-BCJR

Panel Hole Dimensions

## 75Ω Triaxial Connectors

Canare CC series cover global triaxial interconnection. CC-F series are ideal for interconnecting European triax system and CC-K series for American triax system.

### Key Features and Benefits

- True 75Ω, DC 1.5GHz; ≥20dB return loss (≤1.2 VSWR)
- Push-lock mechanism
- no cable stress when detaching to prevent cable break
- Reliable crimp system
- Rugged and durable construction

## CC-F Series

Cable compatibility meets European interconnecting requirements.

Model	Description	Suitable Cable		Boot/Cap	Center contact	Sleeve A	Sleeve B	Crimp Tool
		Canare	Others					
CCF5-JFC	Crimp type, Female cable mount	L-5CFTX	Belden: 7783A Klotz: TRIAX8 Fujikura: 4.8/1.0 EFTXF	CB31	BN9194	BN7120	BN7121	TC-1 + TCD-65C
CCM5-PFC	Crimp type, Male cable mount			CB32	BN1135	BN7120	BN7121	
CCF5-JFRC	Crimp type, Female panel mount			DCF02	BN9194	BN7120	BN7121	
CCM5-PFRC	Crimp type, Male panel mount			DCM02	BN1135	BN7120	BN7121	
CCF7-JFC	Crimp type, Female cable mount	L-7CFTX	Belden: 7784AS Klotz: TRIAX11 Fujikura: SUPERFLEX11	CB31	BN9182A	BN7113	BN7114	TC-2 + TCD-96C
CCM7-PFC	Crimp type, Male cable mount			CB32	BN1131	BN7113	BN7114	
CCF7-JFRC	Crimp type, Female panel mount			DCF02	BN9182A	BN7113	BN7114	
CCM7-PFRC	Crimp type, Male panel mount			DCM02	BN1131	BN7113	BN7114	

## CC-K Series

Cable compatibility meets American interconnecting requirements.

Model	Description	Suitable Cable		Retrofit Kit	Boot/Cap	Crimp Tool
		Canare	Others			
CCF4-JK	Crimp type, Female cable mount	L-4CFTX	Belden: 1856A, 1857A, 9267 Gepco: LVT61859, VT61859	BN9127A	CB23	TC-1 + TCD-316C
CCM4-PK	Crimp type, Male cable mount			BN9128B	CB22	
CCF4-JKR	Crimp type, Female panel mount			BN9127A	DCM02	
CCM4-PKR	Crimp type, Male panel mount			BN9128B	DCM03	

### RCA Pin Connectors

#### RCAP-C Series (Crimp Plugs)

Model	Suitable Cable		Center Pin	Sleeve	Boot	Die Set
	Canare	Others				
RCAP-C25F	L-2.5CFB	1855A, 8218, 1417B, 1418B	B11014E	BN7029C	—	TCD-35CA
RCAP-C25HD	L-2.5CHD	—	B11015E	BN7129	—	TCD-35CA
RCAP-C3A	L-3C2VS, L-3C2V, V*-3C	—	B11014E	BN7003A	CB24	TCD-35CA
RCAP-C3GS	GS-6	—	BN1093	BN7079	CB25	TCD-35D
RCAP-C3F	L-3CFB, V*-3CFB	—	B11015E	BN7003A	CB24	TCD-35CA
RCAP-C42	—	1505F	B11016E	BN7011	—	TCD-31C
RCAP-C4A	LV-61S	8241, 8279, RG-59B/U	B11015E	BN7015A	CB25	TCD-4CA, TCD-451CA
RCAP-C4F	L-4CFB, V*-4CFB	1505A, 1505ANH, 8212, 8241F, 9167, 9259, 9659	B11016E	BN7015A	CB25	TCD-4CA, TCD-451CA
RCAP-C53	L-4.5CHD	1694A, 9066, 9116, 9118, 9248	B11020D	BN7016	CB26	TCD-35CA
RCAP-C5A	L-5C2VS, L-5C2V, V*-5C	—	B11016E	BN7016	CB26	TCD-35CA
RCAP-C5F	L-5CFB, V*-5CFB	—	B11020D	B75004A	CB26	TCD-5CF, TCD-55FA
RCAP-C77	LV-77S	8281F	B11016E	B75004A	CB26	TCD-5CF, TCD-55FA

•Standard package (20pcs/100pcs)

- Canare crimp design ensures quick and reliable installation.
- The crimp tool for the RCAP-C can be used for the Canare crimp BNC plugs as well, thus saving on extra equipment.

Be sure to use the Canare crimping tool for installing connectors on cables.

#### Solder Plugs

Model	Description
F-09	Plug
F-10	Plug (long sleeve)

•Standard package (10 pcs)

- Robust metal shell
- Comfortable grip
- Cable OD up to 6.0 mm.

#### Standoff Receptacle

Model	Description
RJ-JR	Jack to Jack

•Standard package: 20 pcs by insulation color

- Insulation color is available in 5 colors (red, green, blue, yellow, white).
- VSWR 1.2 @ 100Mhz

#### Flush-mount Receptacles

Model	Description	Flange Type
RJ-RU	RCA - Solder	ITT XLR-F77
RJ-RUD		Neutrik D
RJ-RUDB		Neutrik D (Black)
RJ-JRU	RCA - RCA	ITT XLR-F77
RJ-JRUD		Neutrik D
RJ-JRUDB		Neutrik D (Black)
RJ-BCJRU	RCA - BNC	ITT XLR-F77
RJ-BCJRUD		Neutrik D
RJ-BCJRUDB		Neutrik D (Black)

•Standard package: 20 pcs by insulation color

- Three types of flanges are available.
- Insulation color is available in 5 colors (red, green, blue, yellow, white).
- VSWR 1.2 @ 100Mhz

#### <Panel Hole Dimensions>

RJ-JR (*)	ITT XLR-F77 Flange	Neutrik D Flange

(\*) RJ-JR accepts insulation bushing IU-7/16; in this case, panel hole for IU-7/16 should be adopted (see page 33)



RCAP-C3A



F-09

F-10

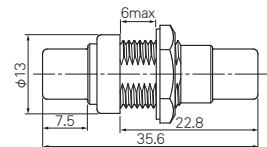

RJ-JR

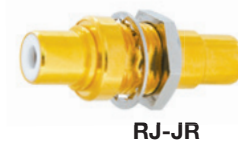

RJ-RU

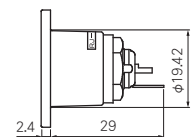

RJ-RU



RJ-RU

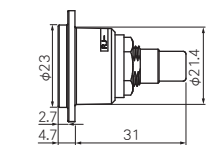

RJ-JRUD

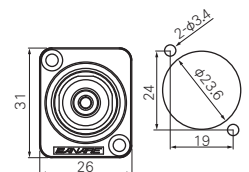

RJ-JRUD



RJ-BCJRU

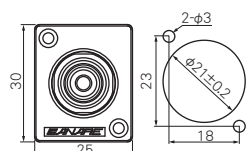
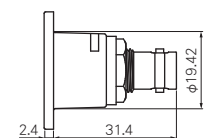

RJ-BCJRU

## F Connectors

This type is used in such applications as home television receivers for cable television (CATV) systems.

### FP-C Series (Crimp Plugs)

Model	Suitable Cable		Center Pin	Sleeve	Boot	Die Set
	Canare	Others				
FP-C25HD	L-2.5CHD	—	BN1003B	BN7129	—	TCD-35CA
FP-C3	L-3C2VS, L-3C2V, V*-3C	—	BN1002B	BN7003A	CB24	TCD-35CA
FP-C31	L-3C2W	—	BN1002B	BN7011	CB25	TCD-31C
FP-C3F	L-3CFB, V*-3CFB	—	BN1003B	BN7003A	CB24	TCD-35CA
FP-C4	LV-61S	8241, 8279, RG-59B/U	BN1003B	BN7015A	CB25	TCD-4CA, TCD-451CA
FP-C4F	L-4CFB, V*-4CFB	1505A, 1505ANH, 8212, 8241F, 9167, 9259, 9659	BN1004B	BN7015A	CB25	TCD-4CA, TCD-451CA
FP-C5	L-5C2VS, L-5C2V, V*-5C	—	BN1004B	BN7016	CB26	TCD-35CA
FP-C52	L-5C2W	—	BN1004B	BN7014	—	TCD-451CA
FP-C53A	L-4.5CHD	1694A, 9066, 9116, 9118, 9248	BN1005B	BN7046	CB26	TCD-35CA
FP-C55A	—	1695A, 89120, 87120, 633948, 9116P	BN1005B	BN7045A	—	TCD-35CA
FP-C5F	L-5CFB, V*-5CFB	—	BN1005B	B75004A	CB26	TCD-5CF, TCD-55FA
FP-C71A	—	7731A, 9064, 9292, 1617A, 9011	BN1041A	BN7021A	—	TCD-7CA
FP-C7FA	L-7CFB	—	BN1030A	BN7021A	—	TCD-7CA

•Standard package (20pcs/100pcs)

- Lock mechanism improves reliability by preventing shifting or detaching of the center pin.
- The tools and cable stripper can be used for the Canare crimp BNC plugs as well, thus saving on extra equipment.
- VSWR of 1.1 or less up to 2GHz. Compatible with broadcast satellite (BS) and communications satellite (CS) signals.
- Designed for indoor use.

Be sure to use the Canare crimping tool for installing connectors on cables.

### Standoff Receptacle

Model	Description
FJ-JR	Jack to Jack
FJ-FPC	PC Board Straight Mount

•Standard package (20pcs/100pcs)

- VSWR of 1.1 or less up to 2GHz. Compatible with broadcast satellite (BS) and communications satellite (CS) signals. <Fig. 1>
- For insulation from the panel, use insulation bushing IU-7/16. (Panel thickness: 1.2~3.0mm)

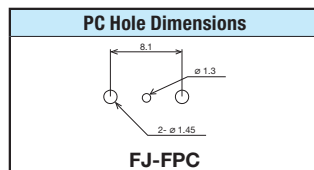
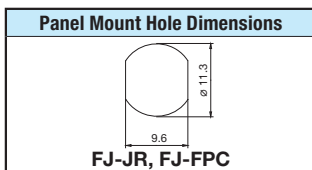

### Flush-mount Receptacles

Model	Description	Flange Type
FJ-JRU	Jack to Jack	ITT XLR-F77
FJ-JRUD		Neutrik D
FJ-JRUDB		Neutrik D (Black)

•Standard package: 20 pcs

- Three types of flanges are available.

### Phone Plugs

Model	Description
F-11	3.5mm Mini Phone TS
F-12	3.5mm Mini Phone TRS
F-15	6.3mm (1/4") TS Phone
F-16	6.3mm (1/4") TRS Phone

•Standard package (10pcs)

- Featuring a properly cable cramp system ensures long life reliability.
- Suited to cables up to 6.0mm $\phi$  in size.

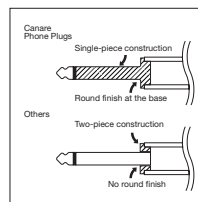
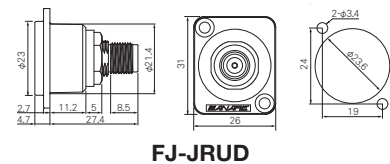
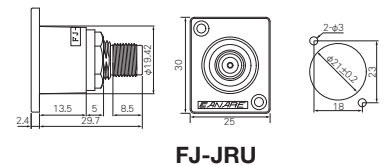
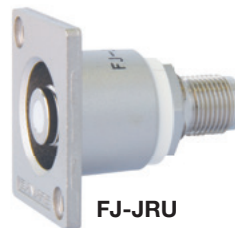
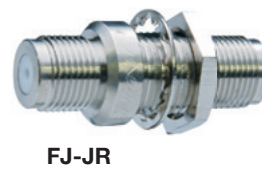
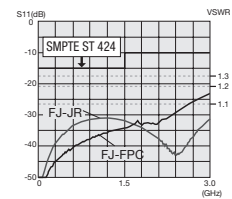



### 50Ω BNC Crimp Plugs

VSWR of 1.1 or less up to 2GHz, 1.2 or less up to 4GHz.

#### ■ BP-C Series

Model	Suitable Cable	Center Pin	Sleeve	Boot	Die Set (Model: TCD-***)		
					55FA	35D	3151D
BP-C3	L-3D2V, 3D-2V	BN1023A	BN7003A	CB03		●	
BP-C31	L-3D2W, 3D-2W	BN1023A	BN7011	CB04			●
BP-C4	RG-58C/U, RG-58A/U	BN1024A	BN7030A	CB03		●	
BP-C5	L-5D2V, 5D-2V	BN1025B	BN7016	CB05A		●	
BP-C5FA	L-5DFB, 5D-FB	BN1016C	B75004A	CB05A	●		
BP-C51	L-5D2W, 5D-2W	BN1025B	BN7002	—			●

•Standard package (20pcs)



BP-C5



BP-LC31

#### ■ BP-LC Series (Right Angle Type)

Model	Suitable Cable	Center Pin	Sleeve	Die Set
BP-LC31	L-3D2W, 3D-2W	BN1023A	BN7011	TCD-3151D
BP-LC51	L-5D2W, 5D-2W	BN1025B	BN7002	

•Standard package (20pcs)

- Lock mechanism used on insulation improves reliability by preventing shifting or detaching of the contact pins.
- Elongated body design for straight type enables easy attachment and removal.
- Gold plating on the contact pin prevents deterioration, even after years of use.
- Use of crimping to attach the connectors ensures quick, reliable installation.

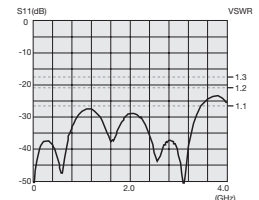

Return loss for BP-C31

Be sure to use the Canare crimping tool for installing connectors on cables.

### 50Ω BNC Receptacles

#### ■ Standoff

Model	Description
BJ-JR	Jack to Jack

•Standard package (20pcs)

- Mounting hole size is same as that for BCJ-R/1 connector.

#### ■ Flush-mount Receptacles

Model	Description	Flange Type
BJ-JRU	Jack to Jack	ITT XLR-F77
BJ-JRUD		Neutrik D

•Standard package (20pcs)

- Two types of flanges are available.
- Flush-mount receptacle prevents damage on the jack.



BJ-JR

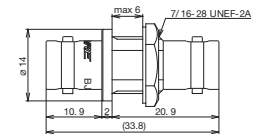

BJ-JR



BJ-JRU

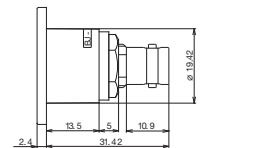

BJ-JRU

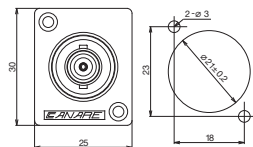

### 50Ω BNC Extension Adapter

Model	Description
BJ-J	Jack to Jack

•Standard package (20pcs)

- VSWR of 1.1 or less up to 4GHz.



BJ-J

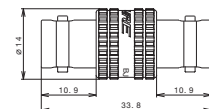

BJ-J

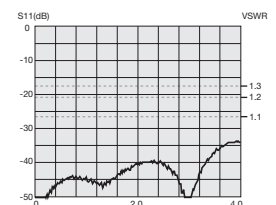

Return loss for BJ-J

50Ω TNC Crimp Plugs

TNP-C Series

Model	Suitable Cable	Boot	Die Set
TNP-C3	L-3D2V, 3D-2V	CB03	TCD-35D
TNP-C31	L-3D2W, 3D-2W	CB04	TCD-3151D
TNP-C4	RG-58C/U, RG-58A/U	CB03	TCD-35D
TNP-C5	L-5D2V, 5D-2V	CB05A	TCD-3151D
TNP-C51	L-5D2W, 5D-2W	—	TCD-3151D
TNP-C5F	L-5DFB, 5D-FB	CB05A	TCD-35DF TCD-55FA

•Standard package (20pcs)

TNP-LC Series (Right Angle Type)

Model	Suitable Cable	Die Set
TNP-LC31	L-3D2W, 3D-2W	TCD-3151D
TNP-LC51	L-5D2W, 5D-2W	

•Standard package (20pcs)

- VSWR of 1.1 or less up to 2GHz, 1.2 or less up to 4GHz.
- Use of crimping to attach the connectors ensures quick, reliable installation.
- Crimping tool can be used for the Canare crimp BNC plugs as well, thus saving on extra equipment.
- Elongated body design for straight type enables easy attachment and removal.

Be sure to use the Canare crimping tool for installing connectors on cables.

50Ω N Crimp Plugs

NP-C Series

Model	Suitable Cable	Boot	Die Set
NP-C31	L-3D2W, 3D-2W	CB04	TCD-3151D
NP-C51	L-5D2W, 5D-2W	—	

•Standard package (20pcs)

NP-LC Series (Right Angle Type)

Model	Suitable Cable	Die Set
NP-LC31	L-3D2W, 3D-2W	TCD-3151D
NP-LC51	L-5D2W, 5D-2W	

•Standard package (20pcs)

- VSWR of 1.1 or less up to 2GHz, 1.2 or less up to 4GHz.
- Lock mechanism used on insulation prevents shifting or detaching of the contact pins.
- Use of crimping to attach the connectors ensures quick, reliable installation.

Be sure to use the Canare crimping tool for installing connectors on cables.

50Ω SMA Crimp Plugs

SMAP-C Series

Model	Suitable Cable	Die Set
SMAP-C1	1.5D-QEW	TCD-1DB
SMAP-C3F	L-3DFB	TCD-35DF
SMAP-C31A	L-3D2W, 3D-2W	TCD-3151D
SMAP-C51	L-5D2W, 5D-2W	
SMAP-C5F	L-5DFB, 5D-FB	TCD-35DF TCD-55FA

•Standard package (20pcs)

SMAJ-C Series

Model	Suitable Cable	Die Set
SMAJ-C3F	L-3DFB	TCD-35DF
SMAJ-C51	L-5D2W, 5D-2W	TCD-3151D
SMAJ-C5F	L-5DFB, 5D-FB	TCD-35DF TCD-55FA

•Standard package (20pcs)

- Center contact for SMAP-C1 is of solder type.
- VSWR of 1.1 or less up to 2GHz, 1.2 or less up to 4GHz. (SMAP-C1: VSWR of 1.2 or less up to 2GHz.)

Be sure to use the Canare crimping tool for installing connectors on cables.



TNP-C3

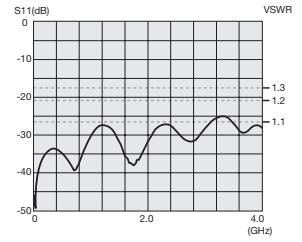

Return loss for TNP-C3



NP-C51

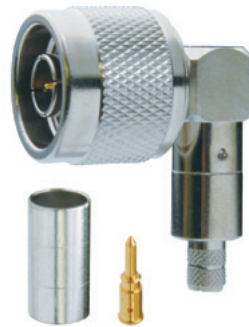

NP-LC31

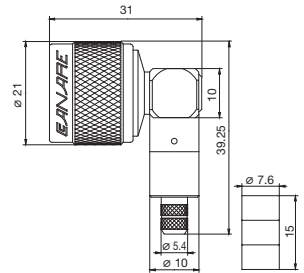

NP-LC31



SMAP-C1

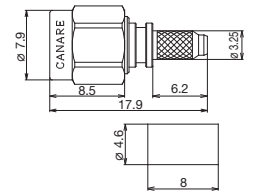

SMAP-C1



SMAP-C31A

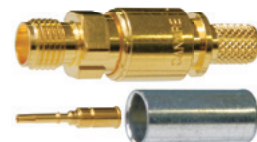
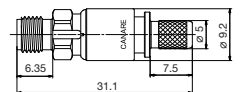

SMAJ-C3F

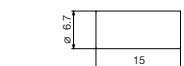

SMAJ-C3F

### Coaxial Cable Stripper

Three internal circular steel blades perform precise, extremely clean and easy stripping.

Model	Preset to
<b>TS100E</b>	LV-77S-L-5CFB, V*-5CFB, V*-5C, LV-61S-L-4CFB, V*-3C
<b>TS100U</b>	L-2.5CHD, 1855A, 1505A, 1694A

- For most Canare BNC, DIN, RCA and F crimp plugs.
- Rotary knob to select 5 different cable setups.
- Make your own cable setting within cable O.D. 4mm~11mm
- Hex wrench is attached on the lid top for quick adjustment.
- One replacement blade included, and also sold separately.  
Replacement blade: TSC (1 pc)

**Note:**

The following types of cables may not be accurately processed by Canare's TS100 Cable Stripper, owing to their construction.

1. Cables employing such hard jacket material as polyethylene.
2. Cables employing such particularly soft insulator material as high-foam polyethylene.
3. Cables employing steel wire and semirigid pipe for outer conductor.



**TS100E**

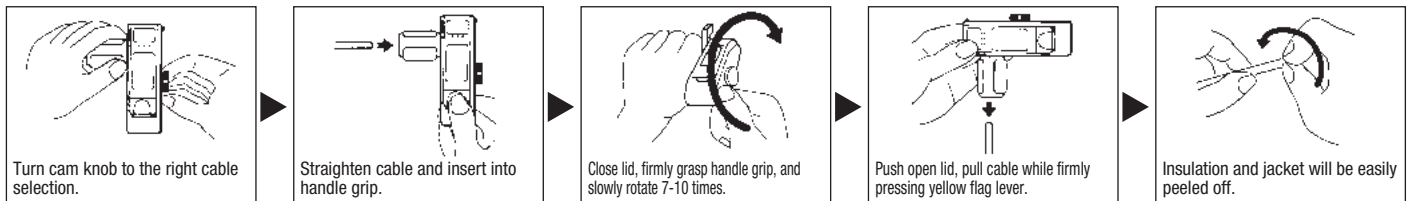
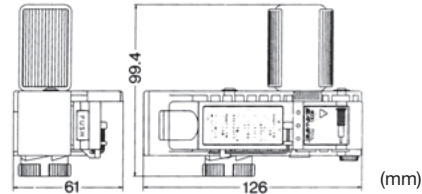

### Crimp Tools

Canare crimp tool offers reliable high-quality crimping performance in an easy-to-use design.

■ Die Sets      ■ Hand Crimp Tools

Model	Model
TCD-1DB	TC-1
TCD-31C	
TCD-3151D	
TCD-316C	
TCD-35CA	
TCD-35D	
TCD-35DF	
TCD-4CA	
TCD-451CA	
TCD-55FA	
TCD-5CF	
TCD-5HD	
TCD-65C	
TCD-67HD	
TCD-7CA	
TCD-96C	TC-2
TCD-D253F	TC-1
TCD-D534F	

■ Accessories

Model	Description	Length
<b>TB-2A</b>	Tool case	—
<b>BET-12</b>	Extraction tool for BNC straight plug	12 inch
<b>BET-MBNC</b>	Extraction tool for MBCP-C series	30 cm
<b>BET-DIN</b>	Insertion / extraction tool for DCP-C series	30 cm

- Select the appropriate die set to suit the individual connector
- Hand crimp tool is required for die set, and sold separately
- Die set are interchangeable

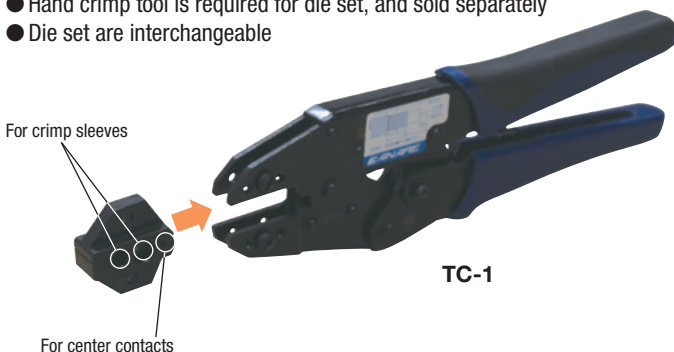

**TC-1**



**TB-2A**  
(tools and connectors not included)



**BET-12**

**BET-MBNC**

**BET-DIN**

## Crimp Connector Assembly Instructions

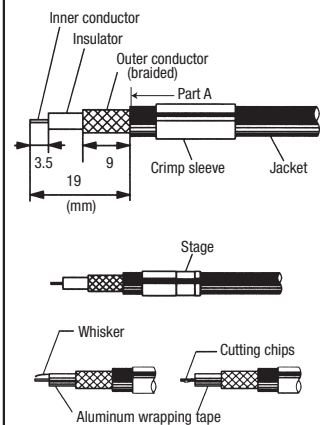

### Confirm compatibility of the connector and cable prior to assembly.

- Slide the crimp sleeve over the cable and strip the jacket, braided shield, and insulation of the coaxial cable as shown at left.
  - For cables with stranded inner conductor, twist the strands in the same direction as plied after removing the insulation.
  - For a crimp sleeve with steps, slip it over the cable from the stepped end, as in the diagram.
  - If any aluminum foil shield is left on the cable, it may get stuck in the mouth of connector, making insertion impossible.
  - Remove all stray strands and offcuts of the aluminum foil shield to avoid possible short circuiting.
  - Make sure the inner conductor is free of all insulation debris and offcuts to ensure complete crimping.

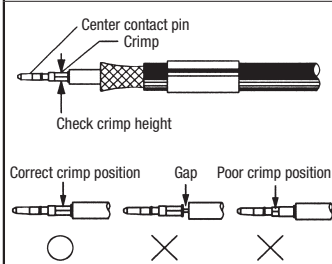

- Place the center contact pin of the connector on the inner conductor of the cable and crimp the center contact pin at the correct position (without remaining a gap) as shown at left, using the specified crimp tool and die set.
  - To confirm the crimping properly, measure the crimp height after removing burrs with a knife. If it is not within the ideal value range, adjust the crimp tool.
  - Do not crimp the center contact pin at the stepped root end.
  - Confirm the center contact pin is crimped straight to the inner conductor. If the center contact pin is slanted, align it gently.

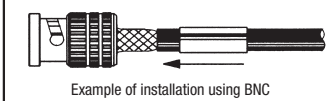

- Hold the cable and push it into the connector body until the center contact is locked in place. You may feel a click sound when the center contact pin is locked.
  - Pull the cable gently (less than 4.5lbs or 19.6N) to confirm that it is locked.

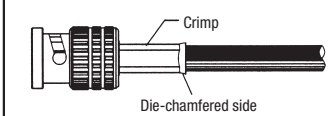

- Slide crimp sleeve up against connector body over the braided shield until it butts against the connector body. Center the die over the crimp sleeve and crimp in place, using the specified crimp tool and die set.
  - Do not pull the cable while crimping is executed.

## Adjusting Crimp Tool

### 1. Measuring Crimping height

Crimp height is measured after the crimp is made. As shown in the figure, the sum of the measured values for both directions is divided by two to arrive at the crimp height. The ideal value range for the BCP-A3 connector, for example, is 1.4mm to 1.5mm. When this value is lower (overcrimping occurs) than the recommended crimp height, the crimp becomes very hard. A value higher (undercrimping occurs) than the recommended value can result in increased electrical resistance and a physically weaker crimp. Either digital calipers or a micrometer should be used for measuring crimp height.

### 2. Measuring Frequency

Crimp height is measured prior to commencing use of the crimp tool and always when changing the crimping die. After this, the crimp height is regularly measured after about each 1,000 crimps.

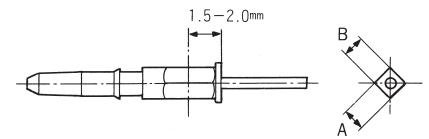

$$\text{Crimp height value} = (A+B) / 2$$

Refer to the separately included manual for the appropriate crimp height values for individual connectors.

### 3. Tool Measuring Procedures

Crimp force increases and crimp height decreases when the tool's adjuster dial is turned in the direction of the 9. The dial is adjusted by first releasing it using a screw driver.



## FAQ

**Q** Does it matter in which direction crimp sleeves are attached?

**A** For BCP-A3—use and other non-stepped (straight type) crimp sleeves, it does not matter in which direction the crimp sleeve is attached. The attachment direction also does not matter for BCP-A5F—use and other specific-use types that have a chamfer (groove) at one end of the crimp sleeve.

However, stepped crimp sleeves such as those for BCP-C1, etc. are directional and must be attached in the direction shown in the diagram below, with the cable threaded through the sleeve starting from the end with the step (that is, the end with smaller-diameter hole).



**Q** What should be done with an aluminum foil shield?

**A** Strip the aluminum foil shield to the root of the braided shield (to the edge of the jacket).

If any aluminum foil shield is left on the cable, it may get stuck in the mouth of connector, making insertion impossible.

**Q** Why do some BNC plugs made by other companies have a sharp point at the tip of the central contact? Are these compatible with Canare's BNC receptacles?

**A** The central contact is pointed in conformance with the JIS standard for 50Ω BNC connectors. The central contacts on Canare's connectors conform to the MIL standard, and therefore are not pointed. These two different shapes simply offer different ways to guide the plug into the female receptacle and have no direct effect on contact quality.

The actual contact surfaces on Canare's BNC connectors are designed in conformance with JIS standards and therefore pose no compatibility problems.

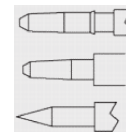

Canare BCP plug

MIL

JIS

**Q** Is it possible to use cables not listed in the connector compatibility table as long as they are close to the dimensions of those listed?

**A** No. While connection may be possible, performance may be adversely affected.

Even if the connection appears to work, factors such as electrical instability, weak cable contact strength and others may cause problems during actual use.

Therefore, it is necessary to test and evaluate whether it is actually possible to use the configuration in question. Particular caution should be used when crimping is involved.

**Q** What is meant by "cable contact strength"?

**A** Cable contact strength refers to the maximum load borne by the cable when exerting tensile force to remove it from the connector. For Canare products, "cable contact strength" refers to the contact strength of a cable's outer conductor, not including the pull-out strength of the central contact or the contact strength of the inner conductor.

**Q** What is the approximate insertion loss associated with connectors?

**A** The value varies depending on the connector, but for BNC plugs the value is approximately 0.1dB per plug (DC–2GHz).



### Cables to Connector Cross-Reference

#### ■ BNC, F, RCA, etc.

See page 43, for more information about the crimp height.

Model	BNC						Jack	F	RCA	Others	Suitable Die Set (*1)	Crimp Height
	Crimp Plug					Solder Plug		FP-C	RCAP-C			
	BCP-B	BCP-A	BCP-C	MBCP-C	BCP-LC	BCP-H						
L-1.5C2VS/V*-1.5C												
1.5C-2V			BCP-C1				BCJ-FC1(-7/16) BCJ-RUC1				TCD-1DB	—
L-2.5C2V		BCP-A25									TCD-35CA	1.40 - 1.47
L-2.5CFB		BCP-A25F		MBCP-C25F					RCAP-C25F			
1855A	BCP-B26											
1855P												
L-2.5CHD/L-2.5CHLT VDM230	BCP-B25HD							FP-C25HD	RCAP-C25HD			
1855ENH	BCP-B28											
HD PRO 0.6/2.8 AF												
1506A		BCP-A32										
V4-2.5CHW	BCP-B25HW											
L-3C2V/L-3C2VS		BCP-A3				BCP-H3B BCP-H5/1						
V3-3C/V4-3C		BCP-A3 BCP-VA3			BCP-LC3			FP-C3	RCAP-C3A	MCM-V5C3 MCF-V5C3		
V5-3C										MCM-V5C3 MCF-V5C3		
L-3CFB	BCP-B3F	BCP-A3F		MBCP-C3F	BCP-LC3F	BCP-H3B BCP-H5/1		FP-C3F	RCAP-C3F			
V*-3CFB												
1695A		BCP-A55						FP-C55A				
VSD2001TS												
L-3C2W		BCP-A31						FP-C31			TCD-31C	
L-3CFW	BCP-B31F					BCP-H31F						
V*-3CFW												
LV-61S		BCP-A4		MBCP-C4			BCJ-C4	FP-C4	RCAP-C4A	WVP-C4A MVP-C4	TCD-4CA or TCD-451CA	1.40 - 1.50
RG-59B/U												
L-4CFB/V*-4CFB				MBCP-C4F				FP-C4F	RCAP-C4F			
1505A, 1505ANH	BCP-B4F	BCP-A4F										
HD PRO 0.8/3.7 AF												
VPM2000												
L-4CHD												
1505F		BCP-A42							RCAP-C42		TCD-31C	
L-4.5CHD	BCP-B53			MBCP-C53				FP-C53A	RCAP-C53			
1694A	BCP-B56											
HD PRO 1.0/4.8 AF	BCP-B56											
L-4.5CHWS	BCP-B45HW					BCP-H45HW					TCD-35CA	
L-5C2V/L-5C2VS		BCP-A5				BCP-H5B BCP-H5/1		FP-C5	RCAP-C5A			
V*-5C		BCP-A5 BCP-VA5			BCP-LC5							
LV-77S		BCP-A77							RCAP-C77			
L-5CFB	BCP-B5F	BCP-A5F (*2)		MBCP-C5F	BCP-LC5F	BCP-H5B BCP-H5/1 BCP-H51F		FP-C5F	RCAP-C5F		TCD-5CF or TCD-55FA excluding BCP-A5F (*2)	
V*-5CFB												
L-5CFW	BCP-B51F					BCP-H51F						
V*-5CFW												
8281F		BCP-A77							RCAP-C77			
L-5C2W		BCP-A52						FP-C52			TCD-451CA	
L-5CHD			BCP-C5HD								TCD-5HD	
L-6CHD			BCP-C6HD								TCD-67HD	
L-7CHD			BCP-C7HD									
L-7CFB			BCP-C7FA					FP-C7FA				
7731A											TCD-7CA	
9292			BCP-C71A					FP-C71A				
L-8CHD										NCP-H8HD	—	
GS-6									RCAP-C3GS		TCD-35D	

#### ■ DIN 1.0/2.3, 4K-DIN

Model	DIN DCP-C	4K-DIN MD	Suitable Die Set	Crimp height
L-2.5CHD/L-2.5CHLT 1855A VDM230	DCP-C25HD		TCD-D253F	1.08 - 1.16
V4-2.5CHW		MDM-V4C25HW MDF-V4C25HW		
L-3CFB	DCP-C3F			
L-4CFB 1505A VPM2000	DCP-C4F		TCD-D534F	1.25 - 1.33
L-4.5CHD 1694A VSD2001	DCP-C53			

\*1: Die set is not required for BCP-H series and NCP-H8HD \*2: Suitable die set for BCP-A5F is TCD-35CA  
See page 40-41, for 50 ohm cables and connectors.

Belden: 1505A, 1505ANH, 1505F, 1506A, 1694A, 1695A, 1855A, 1855ENH, 1855P, 7731A, 8281F, 9292  
Draka: HD PRO 0.6/2.8 AF, HD PRO 0.8/3.7 AF, HD PRO 1.0/4.8 AF  
Gepco: VDM230, VPM2000, VSD2001, VSD2001TS

Note: Be sure to use the right combination of cable, connector and die set for proper connection

## 110Ω-75Ω Impedance Transformers

Passively convert AES/EBU digital audio signals from 110Ω/XLR3 output to a 75Ω BNC coaxial cable and then back again to a 110Ω/XLR3 input.

### ■ Adapter Type 👑

Model	Description
BCJ-XJ-TRC	XLR3 (F) - BNC Jack
BCJ-XP-TRC	XLR3 (M) - BNC Jack
BCJ-XJ-A10TRC	XLR3 (F) - BNC Jack, 10dB Attenuation Pad

### ■ Panel Mount Type

Model	Description (Front - Back)	Flange Type
XJ3F-TRC-BCJ	XLR3 (F) - BNC Jack	ITT XLR-F77
XJ3M-TRC-BCJ	XLR3 (M) - BNC Jack	
BCJ-TRC-XP3F	BNC Jack - XLR (F)	
BCJ-TRC-XP3M	BNC Jack - XLR (M)	
XJ3F-A10TRC-BCJ	XLR3 (F) - BNC Jack, 10dB Attenuation Pad	
BCJ-A10TRC-XP3F	BNC Jack - XLR3 (F), 10dB Attenuation Pad	

- SMPTE 276M and AES3 transmission standards
- Coaxial transmission of 2 channel digital audio
- Allows longer cable runs than 110 ohm twisted pair
- AES/EBU signal distribution using Canare 75 ohm video patchbays

#### BCJ-XJ-TRC / BCJ-XP-TRC

75Ω BNC (unbalanced)      110Ω XLR3 (balanced)

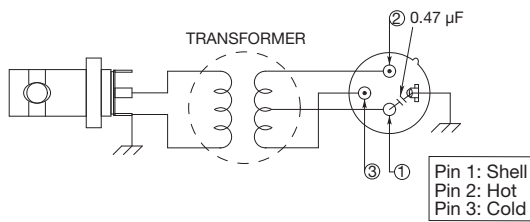

#### BCJ-XJ-A10TRC

75Ω BNC (unbalanced)      110Ω XLR3 (balanced)

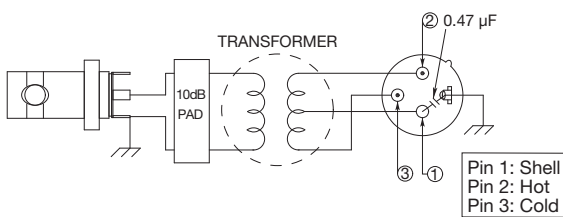

### 110Ω-75Ω Impedance Transformer: Input/Output Level Performance

AES/EBU Transmitter (V)	Transformer Out (V)	AES/EBU Transmitter (V)	Transformer Out -10dB Pad (V)
2.0	1.60	2.0	0.50
3.0	2.39	3.0	0.75
4.0	3.18	4.0	1.01
4.5	3.60	4.5	1.13
5.0	3.98	5.0	1.26
6.0	4.78	6.0	1.51
7.0	5.58	7.0	1.76
8.0	6.38	8.0	2.02
9.0	7.18	9.0	2.27
10.0	7.98	10.0	2.52

BCJ-XJ-TRC/BCJ-XP-TRC

BCJ-XJ-A10TRC



**BCJ-XJ-TRC**



**BCJ-XP-TRC**



**BCJ-XJ-A10TRC**



**XJ3F-TRC-BCJ**



**BCJ-TRC-XP3M**



**BCJ-XJ-TRC**

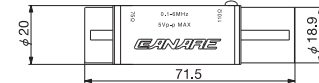

**BCJ-XP-TRC**

Panel Hole Dimensions

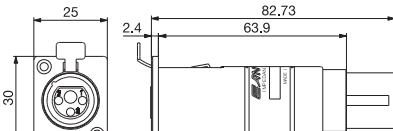
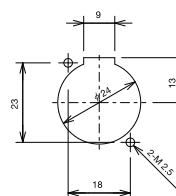

**XJ3F-TRC-BCJ**

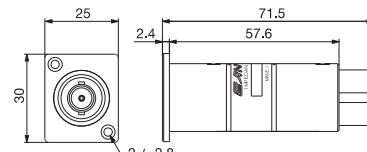

**BCJ-TRC-XP3M**

### Considerations When Configuring and Selecting Cables for Microphone Systems

With the growing demand of recent years for both greater physical comfort and savings in energy consumption, systems incorporating digital control based on the latest advances in electronics are coming into wider use for air conditioning and lighting systems. As all these systems come on line, we cannot help but be reminded of the fact that the wiring used for these digital control systems generates pulse-based electromagnetic noise of the kind that affects the very delicate signals used in microphone lines.

Microphone cables are designed to carry a range of signals that span the spectrum from 1/100 of a volt (10mV) to 1/1,000,000 (1µV). One small error in wiring procedure or cable selection and the entire microphone system turns into an antenna collecting the surrounding noise.

The following section uses a question and answer format to cover a list of the essential points for configuring microphone systems.

#### Q1 Under what sort of conditions should a two-conductor microphone cable be used?

The two-conductor microphone cable is suited to environments where noise is not such a great factor and the audio signals are in the comparatively high -20dB to 0dB level range. In such cases, the two-conductor cable offers the advantages of smaller diameter and lower cost. Of course if microphone level, rather than line level, is the criterion being used, star quad cable should be used instead.

#### Q2 Under what conditions should star quad microphone cable be used?

This type is used for environments with a higher noise factor and where audio signals are in the low -50dB or less range. This type of cable performs well under noise conditions that exceed the capacity of the two-conductor shielded cable, effectively shielding out over ninety percent more noise. (See Figs. 1, 2)

However, should this type be routed alongside a power cable of any significant capacity it should probably be encased in metal conduit just to be safe.

#### Q3 Isn't star quad cable expensive?

The cost for this type of cable has fallen significantly in recent years. Several decades ago, cost was so prohibitive a factor that only large musical auditoriums and broadcasting facilities could afford them. Canare succeeded in developing a low-cost star quad cable using aluminum foil in 1981. In addition to traditional professional facilities, this type gained wide use in such non-traditional areas as wedding halls and school lecture rooms.

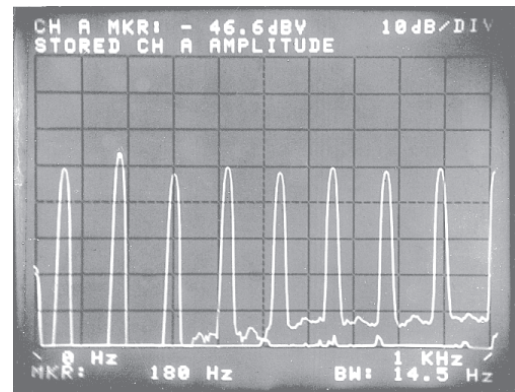

Fig. 1 Noise induced in star quad cable (Canare L-4E5AT)

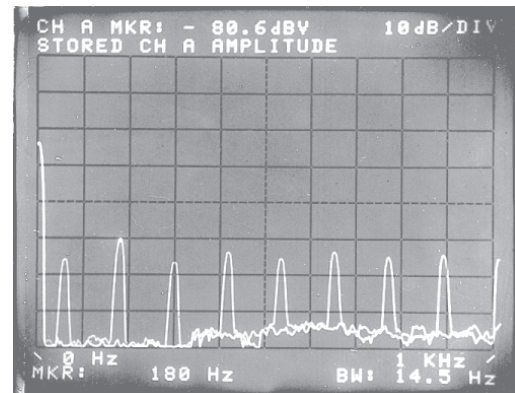
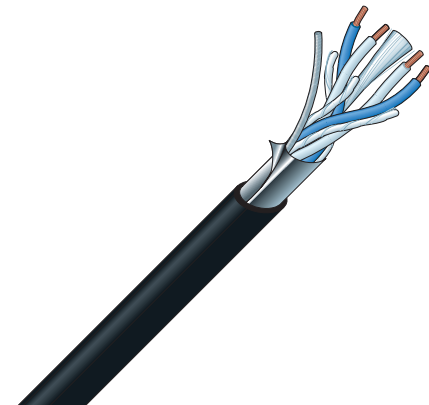

Fig. 2 Noise induced in two-conductor shielded cable (MVVS)

<Test conditions>

1. Flush along power cables for 20m distance
2. Power cable connected to lighting fixture dimmed to 50% capacity with load of 1kW.
3. The noise induced in the audio cable was boosted by 50dB in the head amplifier and viewed on a spectrum analyzer.



Star quad cable with aluminum foil shield

**Q4** When avoiding use of metal conduit, how far away should microphone cable be from power cables?

When foregoing the use of protective metal conduit, use the graph shown in Fig. 3 as a general guide for distancing cables. Note that ignoring basic guidelines for positioning cables can easily result in noise induction problems which are very difficult to deal with later. Encasing microphone cables in metal conduits is highly recommended for applications that utilize the delicate signal range.

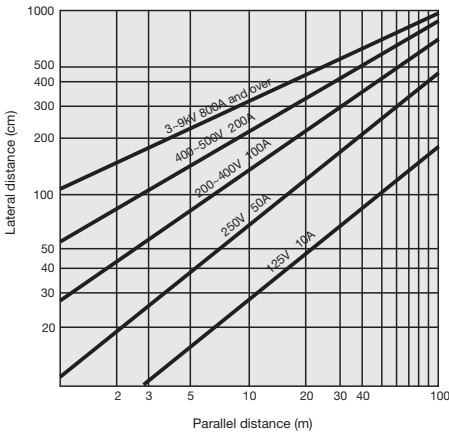

**Fig. 3 Distances for positioning microphone and power cables**

- <Requisite conditions>  
 1. Cables are the star quad type.  
 2. Power cables are in the circular cab tire configuration.

**Q5** What considerations are required when using a rack for strong electric current?

The same as for the preceding question when metal conduit is not used.

**Q6** Would there be any problem with routing the cables through a flexible metal conduit?

The flexible conduit would certainly help to reduce noise but would not be as effective as a rigid metal conduit. Use the graph in Fig. 4 as a guide for distancing cables.

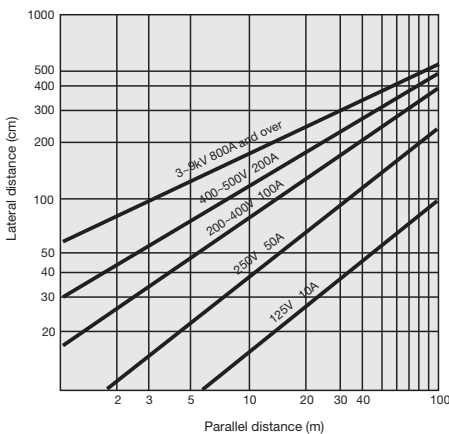
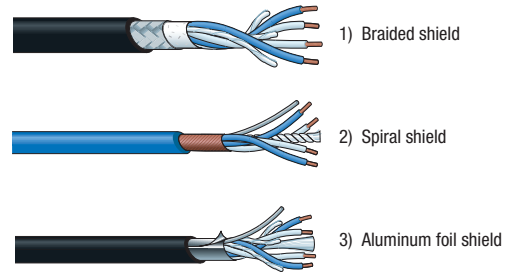

**Fig. 4 Distances for positioning microphone and power cables when routing microphone cables via flexible metal conduit**

- <Requisite conditions>  
 1. Cables are the star quad type routed through flexible metal conduit.  
 2. Metal conduit is grounded using appropriate level of resistance.  
 3. Power cables are in the circular cab tire configuration.

**Q7** What are the criteria for choosing between the many different types of microphone cables?

As all are designed to provide electromagnetic shielding there is not that much basic difference in shielding performance. However, they do differ in various specific characteristics. Cable type should be selected according to specific requirements. (See Fig. 5)



**Fig. 5 Types of star quad microphone cables**

**• Braided Shield**

The braided copper shield is designed to maintain effective shielding performance, regardless of how many times the cable is unwound, bent, twisted or rewound. It is ideal for use as handheld microphone cables or extension cables. This type is more expensive than other types as it is braided very finely to ensure a highly impenetrable shield. Cable termination requires seasoned expertise.

**• Spiral Shield**

The spiral shield consists of several copper wires wound tightly around the cable in a spiral wind. The shielding effect is heightened by winding the shield on twice, each time from different directions in what is referred to as the “double-spiral shield.” The cost range for the spiral shield cable lies roughly mid way between the braided shield and the aluminum foil shield cable. Although cable termination operations are comparatively simple, the spiral shield tends to deteriorate when flexed too frequently. It is designed for stationary installation.

**• Aluminum Foil Shield**

The aluminum foil shield cable consists of aluminum foil fused onto a polyester film and wound around the cable in the form of a tape. Cable termination involves a simple operation and the cable is relatively inexpensive. The aluminum foil cable is recommended for use as stationary cabling.

Aluminum foil cable with a Kevlar cable filler is highly recommended for areas where cables will be routed through metal conduit. The Kevlar filler protects the cable as it passes through the conduit, preventing cable breakage or shorting, even when intense stress is applied to the cable. The aluminum foil cable is currently widely used in function halls and multipurpose track and field stadiums.

**AWG is for Indicating conductor size**

AWG is the abbreviation for American Wire Gauge. For solid center conductor, numbers are decided by conductor O.D. and for stranded center conductor, numbers are decided by conductor cross sectional area. The AWG numbers for conductors used at Canare are listed in Table 1.

AWG	Conductor cross sec. area (mm <sup>2</sup> )	AWG	Conductor cross sec. area (mm <sup>2</sup> )
13	2.81	22	0.34, 0.37, 0.39
14	2.18	23	0.29, 0.30, 0.31
15	1.75	24	0.20, 0.22, 0.23
16	1.27	25	0.18
18	1.0	26	0.14, 0.15
20	0.51, 0.56	28	0.08, 0.09
		31	0.04

**Table 1: AWG Numbers for Cables Used by Canare**



### The Star Quad Story

Canare Star Quad obtains its name from the 4-conductor style construction that minimizes the “loop area” between twists of the conductors. This “double balanced” pairing, reduces susceptibility to electromagnetically induced noise. The improvement in noise rejection is so noticeable, that even SCR dimmer noise (stage lighting consoles), is reduced to less than 1/10 the level found in other 2-conductor microphone cables.

Canare Star Quad is designed for use with microphones but is also excellent for all line-level signals (e.g. mixer to power amps). The 4-conductor Star Quad arrangement, cancels electromagnetically induced

noise from SCR dimmer packs, fluorescent lighting ballasts and AC power transformers. Handling noise is prevented by use of cotton filler material. Excellent frequency response is maintained due to special irradiated polyethylene insulation which provides a low capacitance dielectric.

Canare Star Quad cable with braided shields is super flexible. We use large numbers of thin wire strands in the copper conductors and overall braided shield. We extrude a special compound PVC outer jacket that remains pliant at extremely low temperatures with no wait between cold shipping and installation.

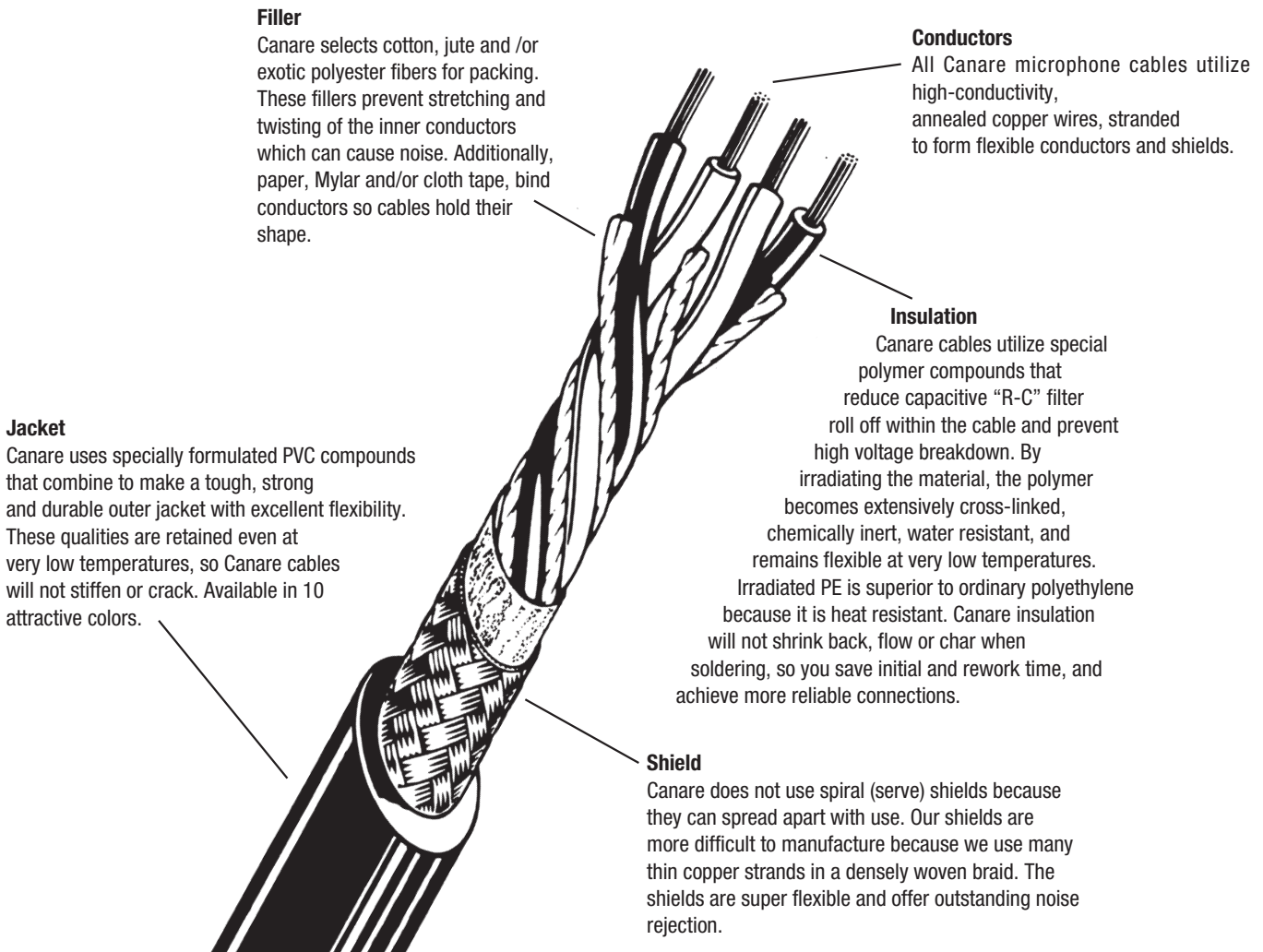

In order to maximize noise rejection, Star Quad must be properly wired to the XLR-3 connector (or terminal block).

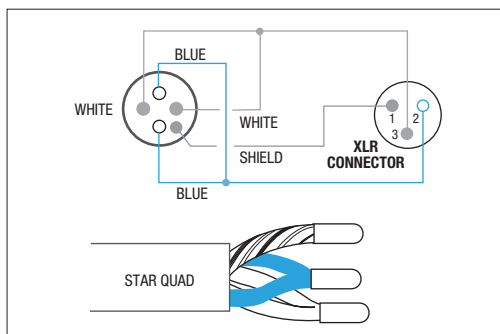

Because the shield density on Canare Cable is very high, it is somewhat difficult to push back the braid and pull the inner conductors through.

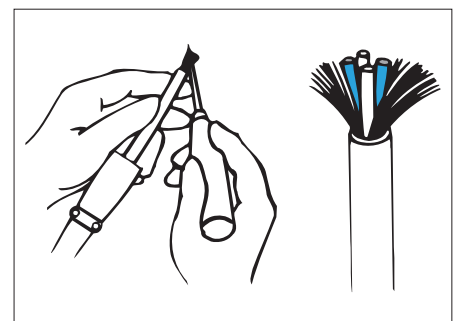

Instead, we strongly recommend unbraiding the shield by “combing” it out with a pointed tool, beginning at the end of the cable.



Star Quad Microphone Cables (Single)

Effectively reduce noise levels to 1/10 that of general-purpose, 2-conductor shielded cables.

Aluminum Foil Shield

Type	Model	Sales units	Nom. O.D	Weight	Composition			Electrical characteristics					
					No. of cond.	Cross sec area (AWG) and cond. comp.	Twist pitch	Cond. D.C.R.	Shield D.C.R.	Nom. cap.*	Nom. cap.**		
								Ω/100m	Ω/100m	pF/m	pF/m		
			m	mm	kg/100m		mm <sup>2</sup> /(AWG) Q'ty/mm	mm					
 L-4E3AT Jacket color: gray	L-4E3AT	200 500	3.0	1.2	4		0.08(28) 7/0.12A	16	24.6	—	—	—	—
 L-4E5AT Jacket colors L-4E5AT, L-4E6AT: gray, black	L-4E5AT L-4E6AT	100 200 400	5.0 6.2	3.3 5.0	4		0.18(25) 16/0.12A 0.31(23) 12/0.18A	21 25	10.7 6.4	—	164	222	210
 L-4E5ATG Jacket color: gray, black	L-4E5ATG L-4E6ATG	100 200 400	5.0 5.8	3.3 4.6	4		0.18(25) 1/0.18(OFC)+30/0.08(OFC) 0.34(22) 1/0.18(OFC)+63/0.08(OFC)	21 35	11.0 5.5	—	164	222	210

Insulation: Cross-linked PE Jacket: PVC Dielectric strength: 500V AC/min.

\*Capacitance between conductors \*\*Capacitance between conductor and shield.

L-4E3AT

- Slim design for internal cabling connection on racks.

L-4E5AT, L-4E6AT

- The Kevlar\* cable filler prevents damage due to excess stretching and stress that may occur when pulling the cable through conduits.
- Drain wire included



\* Kevlar is the registered trademark of Dupont Corporation.

L-4E5ATG, L-4E6ATG

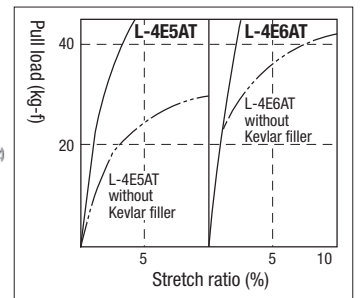
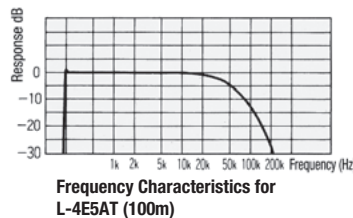
- OFC types of L-4E5AT/L-4E6AT



Braided Shield

Type	Model	Sales units	Nom. O.D	Weight	Composition			Electrical characteristics					
					No. of cond.	Cross sec area (AWG) and cond. comp.	Twist pitch	Shield Coverage (braid)	Cond. D.C.R.	Shield D.C.R.	Nom. cap.*	Nom. cap.**	
									Ω/100m	Ω/100m	pF/m	pF/m	
			m	mm	kg/100m		mm <sup>2</sup> /(AWG) Q'ty/mm	mm	%				
 L-4E6S Jacket colors L-4E6S: black, brown, red, orange, yellow, green, blue, purple, gray, white L-4E5C: black, red, orange, yellow, green, blue, gray	L-4E5C L-4E6S	100 200	4.8 6.0	3.4 4.8	4		0.15(26) 30/0.08A 0.20(24) 40/0.08A	18 20	96% 94%	13.0 9.8	2.4 3.0	162 150	200 185
 L-4E5 Jacket colors L-4E5: gray, black L-4E6: gray	L-4E5 L-4E6	100 200 400	4.8 6.5	3.5 6.1	4		0.15(26) 30/0.08A 0.23(24) 20/0.12A	18 25	96% 96%	13.0 8.6	1.9 1.6	162 144	200 187
 L-4E6-WBS Jacket colors: gray	L-4E6-WBS	100 200	7.0	8.4	4		0.23 (24) 20/0.12A	25	96% & 95%	8.6	1.0	144	185

Insulation: Cross-linked PE Jacket: PVC Dielectric strength: 500V AC/min.

\*Capacitance between conductors. \*\*Capacitance between conductor and shield.

L-4E5, L-4E6

- Bend resistant design: the conductor consists of ultra-fine 0.08 mm strands offers excellent durability.
- High-density braided shield

L-4E5C, L-4E6S

- High-density braided shield
- Drain wire included

L-4E6-WBS

- High-density double-braided shield
- Drain wire included

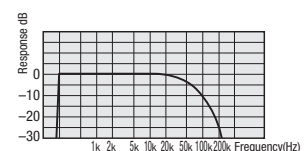

Frequency Characteristics for L-4E6S (100m)

Multichannel Star Quad Microphone Cables

Aluminum Foil Shield

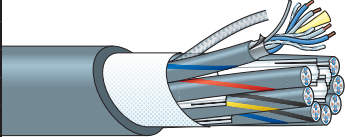
Type	Model	No. of ch.	Sales units	Nom. O.D	Weight	No. of cond.	Unit composition			Electrical characteristics			
							Cross sec area (AWG) and cond. comp.	Twist pitch	Ch. O. D.	Cond. D.C.R.	Shield D.C.R.	Nom. cap.*	Nom. cap.**
							mm <sup>2</sup> /(AWG) Q'ty/mm	mm	mm	Ω/100m	Ω/100m	pF/m	pF/m
 <p>L-4E4-8AT</p> <p>Jacket color: gray</p>	L-4E3-2AT	2	100 200 500	8.5	7.5	8	4E3AT Unit 0.08(28) 7/0.12A	16	3.0	24.8	—	—	—
	L-4E3-4AT	4		10.0	11	16							
	L-4E3-8AT	8		13.8	19	32							
	L-4E3-12AT	12		15.6	26	48							
	L-4E3-16AT	16		17.2	32	64							
	L-4E3-24AT	24		21.3	47	96							
	L-4E4-2AT	2		4E4AT Unit 0.18(25) 16/0.12A	10.5	12	8	21	3.7	10.8	—	164	222
	L-4E4-4AT	4			12.3	17	16						
	L-4E4-8AT	8			16.9	31	32						
	L-4E4-12AT	12			18.9	41	48						
	L-4E4-16AT	16			20.9	50	64						
	L-4E4-24AT	24			26.1	76	96						

Insulation: Cross-linked PE (blue-blue, white-white) Jacket, inner Jacket: PVC Dielectric strength: 500V AC/min. \*Capacitance between conductors \*\*Capacitance between conductor and shield.

L-4E3-\*\*AT, L-4E4-\*\*AT

- The multichannel microphone cable is the cable of choice for music auditorium and studio facilities where noise prevention and audio quality are the prime considerations.
- Each unit contains the highly pull-resistant Kevlar cable filler.
- Drain wire included in each unit.

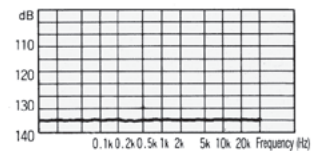
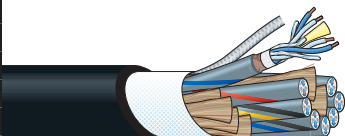

Fig. 1 Crosstalk Characteristics for L-4E4-4AT (100m)

Braided Shield

Type	Model	No. of ch.	Sales units	Nom. O.D	Weight	No. of cond.	Unit composition			Electrical characteristics				
							Cross sec area (AWG) and cond. comp.	Twist pitch	Shield coverage (braid)	Ch. O. D.	Cond. D.C.R.	Shield D.C.R.	Nom. cap.*	Nom. cap.**
							mm <sup>2</sup> /(AWG) Q'ty/mm	mm	%	mm	Ω/100m	Ω/100m	pF/m	pF/m
 <p>L-4E3-8P</p> <p>Jacket color: black (L-4E3-2H gray)</p>	L-4E3-2H	2	100 200 500	8.9	9.5	8	0.08(28) 7/0.12A	16	93%	3.4	24.9	3.4	145	170
	L-4E3-2P	2		8.9	8.2	8								
	L-4E3-4P	4		10.9	14	16								
	L-4E3-8P	8		15.3	26	32								
	L-4E3-12P	12		17.4	36	48								
	L-4E3-16P	16		18.9	43	64								
	L-4E3-24P	24		24.0	70	96								
	L-4E4-2P	2		0.15(26) 30/0.08A	11.1	13	8	16	95%	4.0	13.1	2.4	162	200
	L-4E4-4P	4			13.4	21	16							
	L-4E4-8P	8			18.2	37	32							

Insulation: Cross-linked PE (blue-blue, white-white) Jacket, inner jacket: PVC Dielectric strength: 500V AC/min. \*Capacitance between conductors \*\*Capacitance between conductor and shield.

L-4E3-2H, L-4E3-\*\*P, L-4E4-\*\*P

- Ideal multichannel cable for PA and live events where cables are laid down and taken back up on a regular basis.
- Each unit of L-4E3-2P and L-4E3-2H contains the highly pull-resistant Kevlar cable filler.
- The L-4E3-2H is the reinforced version containing a stainless steel wire support.

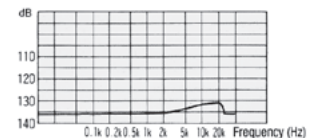
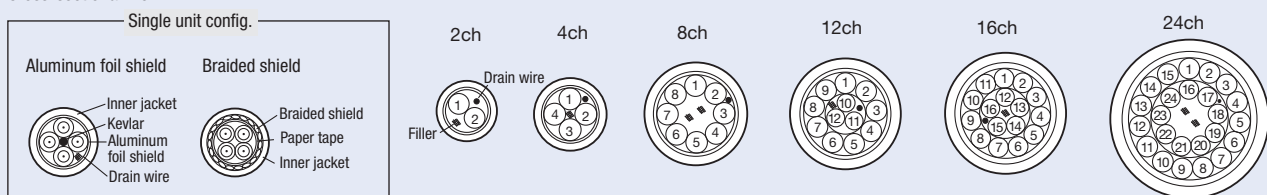

Fig. 1 Crosstalk Characteristics for L-4E4-4P (100m)

Cross-sectional View









Channel color code: Spiral marks on inner jacket (gray).

Unit no.	1	2	3	4	5	6	7	8	9	10	11	12	13	14	15	16	17	18	19	20	21	22	23	24
Spiral mark	RED	BLU	YEL	GRN	BRN	-	BLU/BLK	YEL/BLK	GRN/BLK	BRN/BLK	BLK	BLU/ORN	YEL/ORN	GRN/ORN	BRN/ORN	ORN	BLU/PNK	YEL/PNK	GRN/PNK	BRN/PNK	PNK	BLU/WHT	YEL/WHT	GRN/WHT

Two-Conductor Shielded Cables (Single)

Aluminum Foil Shield

Type	Model	Sales units	Composition					Electrical characteristics			
			Nom. O.D	Weight	No. of cond.	Cross sec area (AWG) and cond. comp.	Twist pitch	Cond. D.C.R.	Shield D.C.R.	Nom. cap.*	Nom. cap.**
			m	mm	kg/100m	mm <sup>2</sup> /(AWG) Q'ty/mm	mm	Ω/100m	Ω/100m	pF/m	pF/m
 <b>L-2B2AT</b> Jacket colors: gray, black	 L-2B2AT	200 500	3.2	1.3	2	0.18(25) 16/0.12A	25	10.5	—	73	120
 <b>L-2B2AL</b> Jacket color: gray	L-2B2AL	200	3.2	1.2	2	0.18(25) 7/0.18TA Overall tin coated	20	11.3	—	—	—
 <b>L-2E5AT</b> Jacket colors: gray, black, sepia	 L-2E5AT	200	5.0	3.3	2	0.31(23) 12/0.18A	30	6.2	—	79	140
 <b>L-2E5AL</b> Jacket color: gray	L-2E5AL	200 500	5.0	3.3	2	0.29(23) 7/0.23TA Overall tin coated	30	6.8	—	—	—

Insulation: Cross-linked PE (polyethylene for L-2E5AL and L-2B2AL) Jacket: PVC Dielectric strength: 500V AC/min. \*Capacitance between conductors \*\*Capacitance between conductor and shield.

L-2B2AT, L-2E5AT

- Ideal for internal rack wiring.
- Drain wire included.
- The L-2E5AT contains the Teton cable filler reinforcement material. <Fig. 1>

L-2B2AL, L-2E5AL

- Cables for connecting devices with which wrapping tools can be used.
- Drain wire included.

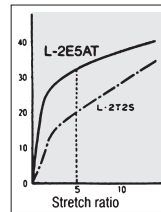

Fig. 1 Pull Load and Stretch Ratio for Cable

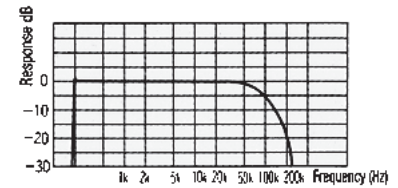



Fig. 2 Frequency Characteristics for L-2B2AT (100m)

Braided Shield

Type	Model	Sales units	Composition					Electrical characteristics				
			Nom. O.D	Weight	No. of cond.	Cross sec area (AWG) and cond. comp.	Twist pitch	Shield coverage (braid)	Cond. D.C.R.	Shield D.C.R.	Nom. cap.*	Nom. cap.**
			m	mm	kg/100m	mm <sup>2</sup> /(AWG) Q'ty/mm	mm	%	Ω/100m	Ω/100m	pF/m	pF/m
 <b>L-2T2S</b>	L-2T2S	100 200	6.0	4.6	2	0.30(23) 60/0.08A	20	94%	6.4	3.1	70	106
Jacket colors for L-2T2S: black, red, orange, yellow, blue, gray for L-2E5: black	L-2E5	200	4.6	3.0	2	0.15(26) 30/0.08A	18	97%	12.7	2.2	—	—

Insulation: Cross-linked PE Jacket: PVC Dielectric strength: 500V AC/min.

\*Capacitance between conductors \*\*Capacitance between conductor and shield.



L-2T2S, L-2E5

- Braid coverage of 94% and above provides dense shielding that blocks out electromagnetic noise.
- L-2T2S consists of 60 ultra-fine 0.08mm strands (30 for L-2E5) in a stranded format that offers excellent durability.
- Highly pliable and durable PVC used for jacket. (Brittle temp. -49°C)



## Two-Conductor Shielded Cables

### ■ Spiral Shield

Type	Model	Sales units	Composition						Electrical characteristics			
			Nom. O.D	Weight	No. of cond.	Cross sec area (AWG) and cond. comp.	Twist pitch	Shield coverage	Cond. D.C.R.	Shield D.C.R.	Nom. cap.*	Nom. cap.**
			m	mm	kg/100m	mm <sup>2</sup> /(AWG) Q'ty/mm	mm	%	Ω/100m	Ω/100m	pF/m	pF/m
 <b>MS202</b> Jacket color: black	<b>MS202</b>	200	2.8	1.4	2	0.18 (25) 1/0.18TA + 30/0.08TA	25	91% (spiral)	11.0	3.2	74	145
 <b>MS203</b> Jacket color: gray		200	3.5	2.1	2	0.31(23) 12/0.18TA	30	91% (spiral)	6.5	2.3	—	—

Insulation: Cross-linked PE Jacket: PVC Dielectric strength: 500V AC/min.

\*Capacitance between conductors \*\*Capacitance between conductor and shield.

#### MS202

- Ideal for analog audio internal rack wiring.
- Composite conductors with 1 of 0.18mm and 30 of 0.08mm strands.
- Drain wire included.

#### MS203

- Ideal for internal rack wiring.
- Drain wire included.

## Two-Conductor Shielded Multichannel Cables

### ■ Aluminum Foil Shield

Type	Model	No. of ch.	Sales units	Nom. O.D	Weight	No. of cond.	Unit composition			Electrical characteristics			
							Cross sec area (AWG) and cond. comp.	Twist pitch	Ch. O. D.	Cond. D.C.R.	Shield D.C.R.	Nom. cap.*	Nom. cap.**
							mm <sup>2</sup> /(AWG) Q'ty/mm	mm	mm	Ω/100m	Ω/100m	pF/m	pF/m
 <b>L-2E4-2AL</b> Jacket color : gray	<b>L-2E4-2AL</b>	2	100	8.6	7.6	4	0.29(23) 7/0.23TA Overall tin coated	30	3.7	6.9	—	81	144
	<b>L-2E4-4AL</b>	4		10.8	13	8							
	<b>L-2E4-8AL</b>	8		14.9	24	16							
	<b>L-2E4-12AL</b>	12		16.9	32	24							
	<b>L-2E4-16AL</b>	16		18.8	40	32							

Insulation: Cross-linked PE Jacket: PVC Dielectric strength: 500V AC/min.

\*Capacitance between conductors \*\*Capacitance between conductor and shield.

#### L-2E4-AL Series

- Used as cables for connecting devices with which wrapping tools can be used.
- Drain wire included in each unit.

No.	Dot line markings
1	—
2	—
3	—
4	—
5	—
6	—
7	—
8	—
9	—
0	—

#### ■ Cross-sectional View

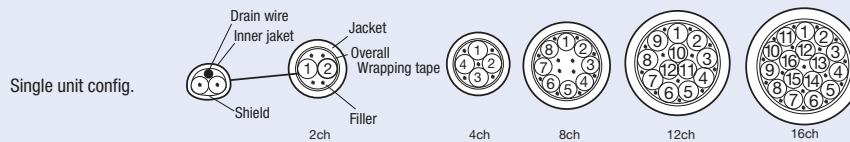

■ Channel color code: color-coded insulation and dot line makings (ch 1 to 10: red, ch 11 to 16: blue) on inner jacket (gray).

Unit no.	1	2	3	4	5	6	7	8	9	10	11	12	13	14	15	16
Insulation color	RED/	BLU/	YEL/	GRN/	BRN/	GRY/	BLU/	YEL/	GRN/	BRN/	GRY/	BLU/	YEL/	GRN/	BRN/	GRY/
	WHT	WHT	WHT	WHT	WHT	WHT	BLK	BLK	BLK	BLK	BLK	ORN	ORN	ORN	ORN	ORN

## Aluminum Foil Shield

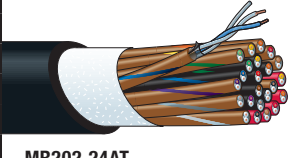
Type	Model	No. of ch.	Sales units	Nom. O.D	Weight	No. of cond.	Unit composition			Electrical characteristics				
							Cross sec area (AWG) and cond. comp.		Twist pitch	Ch. O. D.	Cond. D.C.R.	Shield D.C.R.	Nom. cap.*	Nom. cap.**
							mm <sup>2</sup> /(AWG) Q'ty/mm							
 <b>M202-24AT</b> Jacket color: black	<b>M202-2AT</b>	2	100 200 500	6.5	4.6	4	0.18(25) 16/0.12A	30	—	10.5	—	75	135	
	<b>M202-4AT</b>	4		8.1	7.5	8								
	<b>M202-8AT</b>	8		11.1	13	16								
	<b>M202-12AT</b>	12		12.5	18	24								
	<b>M202-16AT</b>	16		13.8	22	32								
	<b>M202-24AT</b>	24		17.0	32	48								
	<b>M202-32AT</b>	32		18.6	40	64								
 <b>MR202-24AT</b> Jacket color: black	<b>MR202-2AT</b>	2	100 200 500	6.7	4.5	4	0.18(25) 7/0.18A	25	2.7	10.7	—	76	142	
	<b>MR202-4AT</b>	4		7.6	6.2	8								
	<b>MR202-8AT</b>	8		11.0	13	16								
	<b>MR202-12AT</b>	12		12.7	19	24								
	<b>MR202-16AT</b>	16		14.0	23	32								
	<b>MR202-24AT</b>	24		17.4	34	48								
	<b>MR202-32AT</b>	32		19.1	44	64								

Insulation: Cross-linked PE Jacket: PVC Dielectric strength: 500V AC/min.

\*Capacitance between conductors \*\*Capacitance between conductor and shield.

### M202-AT Series

- Multichannel cable featuring light weight and slim form. At only 16kg for a 50m length of 24 channel cable, the M202-AT achieves a 47% weight reduction over previous Canare cables.
- Each channel is individually isolated using insulated (PET) aluminum foil shield. <Fig. 1>
- Contains the highly pull-resistant Kevlar cable filler.
- Drain wire included.

#### Note:

This series does not have inner jacket, so it cannot be used for fantails.

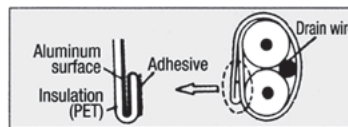
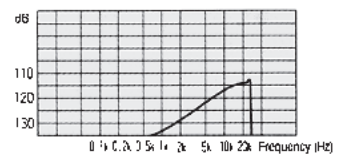

Fig. 1 Aluminum Foil Shield



Crosstalk Characteristics for M202-24AT (100m)

### ■ Cross-sectional View



### ■ Channel color code:

Unit no.	1	2	3	4	5	6	7	8	9	10	11	12	13	14	15	16	17	18	19	20	21	22	23	24	25	26	27	28	29	30	31	32
Insulation color	RED/ WHT	BLU/ WHT	YEL/ WHT	GRN/ WHT	BRN/ WHT	GRY/ WHT	BLU/ BLK	YEL/ BLK	GRN/ BLK	BRN/ BLK	GRY/ BLK	BLU/ ORN	YEL/ ORN	GRN/ ORN	BRN/ ORN	GRY/ ORN	BLU/ PNK	YEL/ PNK	GRN/ PNK	BRN/ PNK	GRY/ PNK	BLU/ RED	YEL/ RED	GRN/ RED	BRN/ RED	GRY/ BLU	BLU/ BLU	PPL/ BLU	GRY/ BLU	BRN/ YEL	GRN/ YEL	BLK/ YEL

### MR202-AT Series

Our bestselling two-conductor multichannel cable featuring AWG25 stranded conductor, 100% shielding by aluminum foil, and drain wire.

- Studio interconnect, portable snake system
- Each channel identified per resistor color-coding
- Aluminum foil shield and drain wire for easy terminate

#### Note:

Not appropriate for heavy-duty applications.

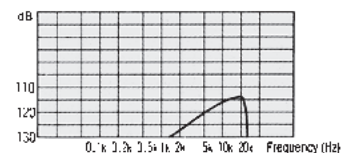

Crosstalk Characteristics for MR202-24AT (100m)

### ■ Cross-sectional View

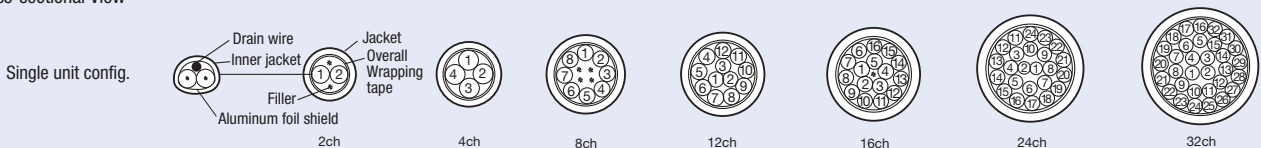

### ■ Channel color code: Inner jacket color coding and spiral markings.\* Insulation inside units: one is clear and the other bears the same color as the spiral markings.

Unit no.	1	2	3	4	5	6	7	8	9	10	11	12	13	14	15	16	17	18	19	20	21	22	23	24	25	26	27	28	29	30	31	32
Insulation color	BRN	RED	ORN	YEL	GRN	BLU	PPL	GRY	WHT	BLK	BRN	RED	ORN	YEL	GRN	BLU	PPL	GRY	WHT	BLK	BRN	RED	ORN	YEL	GRN	BLU	PPL	GRY	WHT	BLK	BRN	RED
Spiral markings	BRN	RED	ORN	YEL	GRN	BLU	PPL	GRY	WHT	BLK	—	RED	ORN	YEL	GRN	BLU	PPL	GRY	WHT	BLK	BRN	—	ORN	YEL	GRN	BLU	PPL	GRY	WHT	BLK	BRN	RED
Inner jacket color	BLK				BRN												RED												ORN			

## Two-Conductor Shielded Cables

### ■ Spiral Shield

Type	Model	No. of ch.	Sales units	Nom. O.D	Weight	No. of cond.	Unit composition				Electrical characteristics			
							Cross sec area (AWG) and cond. comp.	Twist pitch	Shield coverage	Unit O.D.	Cond. D.C.R.	Shield D.C.R.	Nom. cap.*	Nom. cap.**
							mm <sup>2</sup> /(AWG) Q'ty/mm	mm	%	mm	Ω/100m	Ω/100m	pF/m	pF/m
	MS202-2P	2	100 200 500	7.1	5.9	4	0.18 (25) 1/0.18TA + 30/0.08TA	25	91% (spiral)	2.8	11.0	3.2	74	145
	MS202-4P	4		8.2	9.2	8								
	MS202-8P	8		10.9	16.0	16								
	MS202-12P	12		13.6	24.2	24								

Jacket color: black

Insulation: Cross-linked PE, Jacket: PVC Dielectric strength: 500V AC/min.

\*Capacitance between conductors \*\*Capacitance between conductor and shield.

### MS202-P Series

- Multichannel cable for analog audio.
- Composite conductors with 1 of 0.18 mm and 30 of 0.08 mm strands.
- Easy-to-use color-coded units and spiral shield.
- Drain wire included in each unit.

■ Cross-sectional View

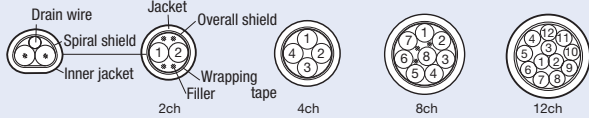

Single unit config.

■ Channel color code:

Unit no.	1	2	3	4	5	6	7	8	9	10	11	12
Insulation color	BRN	RED	ORN	YEL	GRN	BLU	PPL	GRY	WHT	BLK	BRN	RED
Spiral markings	BRN	RED	ORN	YEL	GRN	BLU	PPL	GRY	WHT	BLK	-	RED
Inner jacket color	BLK										BRN	

### ■ Spiral Shield

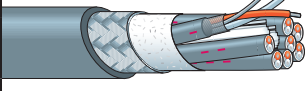
Type	Model	No. of ch.	Sales units	Nom. O.D	Weight	No. of cond.	Unit composition				Overall shield coverage (braid)	Electrical characteristics			
							Cross sec area (AWG) and cond. comp.	Twist pitch	Shield coverage	Unit O.D.		Cond. D.C.R.	Shield D.C.R.	Nom. cap.*	Nom. cap.**
							mm <sup>2</sup> /(AWG) Q'ty/mm	mm	%	mm		Ω/100m	Ω/100m	pF/m	pF/m
	MS203-2BS	2	100 200 500	8.9	11.0	4	0.31(23) 12/0.18TA	30	91% (spiral)	3.5	79%	6.6	2.3	—	—
	MS203-4BS	4		10.3	15.8	8					80%				
	MS203-8BS	8		13.5	27.0	16									

Insulation: Cross-linked PE (orange, white) Jacket: PVC Dielectric strength: 500V AC/min.

\*Capacitance between conductors \*\*Capacitance between conductor and shield.

### MS203-BS Series

- Multichannel version of MS203. (See page 52)
- Overall braided shield enables robust shielding performance.
- Drain wire included in each unit.

No.	Dot line markings											
1	-	-	-	-	-	-	-	-	-	-	-	-
2	-	-	-	-	-	-	-	-	-	-	-	-
3	-	-	-	-	-	-	-	-	-	-	-	-
4	-	-	-	-	-	-	-	-	-	-	-	-
5	-	-	-	-	-	-	-	-	-	-	-	-
6	-	-	-	-	-	-	-	-	-	-	-	-
7	-	-	-	-	-	-	-	-	-	-	-	-
8	-	-	-	-	-	-	-	-	-	-	-	-
9	-	-	-	-	-	-	-	-	-	-	-	-
0	-	-	-	-	-	-	-	-	-	-	-	-

■ Cross-sectional View

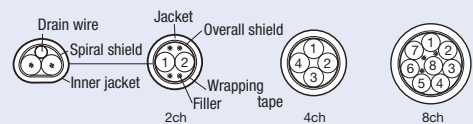





Single unit config.

■ Unit ID: by dot line markings

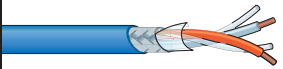
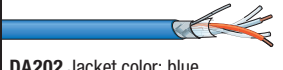
## AES/EBU Digital Audio Cables

Ideal for conveying digital audio signals in conformance with AES/EBU and IEC standards.

Type	No. of ch.	Model	Sales units	Nom. O.D	Weight	Unit composition				Electrical characteristics				Charac-teristic impedance	Attenua-tion
						Cross sec area (AWG) and cond. comp.	Twist pitch	Shield cov-erage (braid)	Unit O.D.	Cond. D.C.R	Shield D.C.R.	Nom. cap.*	Nom. cap.**		
			m	mm	kg/100m	mm <sup>2</sup> /(AWG) Q'ty/mm	mm	%	mm	Ω/100m	Ω/100m	pF/m	pF/m	Ω	dB/100m (3MHz)
 DA206 Jacket color: blue	1	DA206	100 200	7.3	7.5	0.56(20) 7/0.32A	60	95%	—	3.3	1.4	48	73	110	2.6
 DA202 Jacket color: blue	1	DA202	100 200	5.0	3.7	0.18(25) 7/0.18A	32	95%	—	10.6	2.2	45	—	110	5.1
 DA202AT Jacket color: blue	1	DA202AT	100 200	4.0	1.6	0.18(25) 7/0.18A	38	—	—	10.6	—	45	—	110	6.7
 DA203AL Jacket color: blue	1	DA203AL	100 200	6.0	4.2	0.29(23) 7/0.23TA Overall tin coated	45	—	—	6.8	—	48	95	110	5.4
 DA202F-8P Jacket color: blue	2	DA202F-2P	100 200 500	7.7	6.7	0.18(25) 7/0.18TA	25	91% Spiral shield	3.0	11.3	3.0	47	95	110	5.6
	4	DA202F-4P		8.8	10										
	8	DA202F-8P		11.5	17										
 DA203-4AL Jacket color: blue	2	DA203-2AL	100 200 500	11.8	12	0.29(23) 7/0.23TA Overall tin coated	42	—	4.9	6.9	—	48	95	110	5.4
	4	DA203-4AL		13.8	18										
	8	DA203-8AL		19.3	33										
	12	DA203-12AL		21.9	44										

Insulation: Cross-linked PE (DA202F-P: Cross-linked foam PE) Jacket: PVC Dielectric strength: 500V AC/min. \*Capacitance between conductors \*\*Capacitance between conductor and shield.

### DA206, DA202

- PE rod configuration ensures consistent 110Ω impedance with large or small bends in cable during installation.
- DA206 ideal for digital audio paths up to 360m\*.
- DA202 ideal for digital audio paths up to 180m\*.
- DA202 contains a drain wire.

### DA202AT

- Designed for internal cabling connections on racks.
- Ideal for digital audio paths up to 140m\*.
- Drain wire included.

\*Condition: AES3 SR48kHz

### DA203-AL Series

- Wrapping tool can be used.
- Ideal for digital audio paths up to 170m\*.
- Drain wire included in each unit.

### DA202F Series

- Slim and lightweight.
- DA202F-8P designed to fit snugly with D-sub 25 pin connector.
- Cross-linked foam PE insulation.
- Ideal for digital audio paths up to 140m\*.
- Drain wire included in each unit.

### Channel Color Coding

DA202F-P: by the insulator color & the spiral markings on the inner jacket (blue).

Unit no.	1	2	3	4	5	6	7	8
Insulator Color	BRN, WHT	RED, WHT	ORG, WHT	YEL, WHT	GRN, WHT	BLU, WHT	PUR, WHT	GRY, WHT
Spiral Markings	BRN	RED	ORG	YEL	GRN	—	PUR	GRY

DA203-AL: by the insulator color & the spiral markings on the inner jacket (gray).

Unit no.	1	2	3	4	5	6	7	8	9	10	11	12
Insulator Color	RED, WHT	BLU, WHT	YEL, WHT	GRN, WHT	BRN, WHT	GRY, WHT	BLU, BLK	YEL, BLK	GRN, BLK	BRN, BLK	GRY, BLK	BLU, ORG
Spiral Markings	RED	BLU	YEL	GRN	BRN	—	BLU, BLK	YEL, BLK	GRN, BLK	BRN, BLK	BLK	BLU, ORG

### Cross-sectional View for DA202F-P & DA203-AL

Single Unit Config.  
DA202F-P, DA203-AL

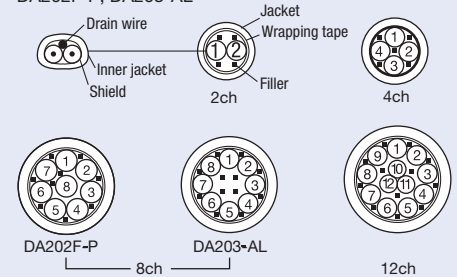



Speaker Cables (Single)

Four-conductor configuration minimizes noise and polyethylene insulation reduces induction rate to boost frequency characteristics

4-conductor Speaker Cable

Type	Model	Pair cross-sec mm <sup>2</sup>	Sales units m	Nom. O.D mm	Weight kg/100m	Composition				Electrical characteristics	
						No. of cond.	Cross sec area (AWG) mm <sup>2</sup> /(AWG)	Cond. comp Q'ty/mm	Twist pitch mm	Cond. D.C.R. Ω/100m	Nom. capacitance* pF/m
 <b>4S8</b> Jacket color for 4S6: gray, black, red, blue, cream for 4S8, 4S11, 4S6G: gray, black for 4S8G, 4S11G: gray	4S6	1.0	100 200 400	6.4	5.4	4	0.51(20)	20/0.18A	45	3.7	125
	4S8	2.5		8.3	9.5	4	1.27(16)	50/0.18A	70	1.5	145
	4S11	4.3		10.7	16	4	2.18(14)	41/0.26A	100	0.9	146
	4S6G	1.0		6.4	5.4	4	0.51(20)	20/0.18(OFC)	45	3.7	125
	4S8G	2.5		8.3	9.5	4	1.27(16)	50/0.18(OFC)	70	1.5	145
	4S11G	4.3		10.7	16	4	2.18(14)	41/0.26(OFC)	100	0.9	146

Insulation: polyethylene (red, translucent red, white, translucent white) Jacket: PVC Dielectric strength: 500V AC/min.

\*Capacitance between conductors.

4S6, 4S8, 4S11

- High-performance PVC jacket, resistant to bending and twisting.
- 4S6 designed to fit snugly with Cannon XLR.

4S6G, 4S8G, 4S11G

- The G versions feature oxygen-free copper (OFC, JIS H3510) conductors.

4-conductor Speaker Cable for Fixed Installation

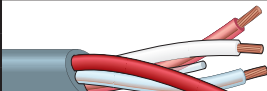
Type	Model	Pair cross-sec mm <sup>2</sup>	Sales units m	Nom. O.D mm	Weight kg/100m	Composition				Electrical characteristics	
						No. of cond.	Cross sec area (AWG) mm <sup>2</sup> /(AWG)	Cond. comp Q'ty/mm	Twist pitch mm	Cond. D.C.R. Ω/100m	Nom. capacitance* pF/m
 <b>4S10F</b> Jacket color for 4S10F, 4S12F, 4S14F, 4S18F: gray, black for 4S10FG, 4S12FG: gray	4S10F	3.5	100 200 400 1000	9.6	15	4	1.75(15)	33/0.26A	100	1.1	144
	4S12F	5.6		11.6	22	4	2.81(13)	35/0.32A	120	0.7	152
	4S14F	8.0		14.0	32	4	4.0(12)	50/0.32A	120	0.5	—
	4S18F	14.2		17.5	53	4	7.08(9)	88/0.32A	150	0.3	—
	4S10FG	3.5		9.6	15	4	1.75(15)	33/0.26(OFC)	100	1.1	144
	4S12FG	5.6		11.6	22	4	2.8(13)	35/0.32(OFC)	120	0.7	152

Insulation: polyethylene (red, translucent red, white, translucent white) Jacket: PVC Dielectric strength: 500V AC/min.

\*Capacitance between conductors.

4S10F, 4S12F, 4S14F, 4S18F

- Special supple jacket designed for use in building conduits.

4S10FG, 4S12FG

- The G versions feature oxygen-free copper (OFC, JIS H3510) conductors.

Multichannel Speaker Cables

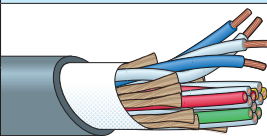
Type	Model	Pair cross-sec mm <sup>2</sup>	Sales units m	Nom. O.D mm	Weight kg/100m	Unit composition				Electrical characteristics	
						No. of cond.	Cross sec area (AWG) and cond. comp. mm <sup>2</sup> /(AWG) Q'ty/mm	Twist pitch mm	Ch. O. D. mm	Cond. D.C.R. Ω/100m	Nom. cap.* pF/m
 <b>S410-4P</b> Jacket color: gray	S410-4P	2.0	100 200 500	15.0	26	16	1.0(18) 127/0.10(OFC)	50	5.1	1.9	165
	S410-6P	2.0		18.3	39	24					
	S410-8P	2.0		21.6	53	32					

Insulation: Polyethylene Jacket: PVC Dielectric strength: 500V AC/min.

\*Capacitance between conductors.

S410-P Series

- Low crosstalk performance
- Ideal for use in multi-way speaker systems.
- Oxygen-free copper (OFC, JIS H3510) conductors.

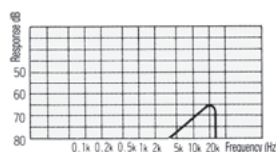



Fig. 1 Crosstalk Characteristics for S410-4P

■ Cross-sectional View of S410-4P and Channel color coding

Unit no.	1	2	3	4	5	6	7	8
Insulation color	RED/WHT/ RED/WHT	BLU/WHT/ BLU/WHT	YEL/WHT/ YEL/WHT	GRN/WHT/ GRN/WHT	BRN/WHE/ BRN/WHT	GRY/WHT/ GRY/WHT	BLU/BLK/ BLU/BLK	YEL/BLK/ YEL/BLK

Speaker Cables (Single)

2-conductor Speaker Cable for Fixed Installation

Type	Model	Sales units	Nom. O.D	Weight	Composition			Electrical characteristics	
					No. of cond.	Cross sec area(AWG)	Twist pitch	Cond. D.C.R.	Nom. capacitance*
						Cond. comp.			
		m	mm	kg/100m		mm <sup>2</sup> (AWG) Q'ty/mm	mm	Ω/100m	pF/m
 <p>2S11F</p> <p>Jacket color: gray, black</p>	2S7F	100 200 400	6.8	5.2	2	1.27(16) 50/0.18A	50	1.5	—
	2S9F		8.9	8.7	2	2.18(14) 41/0.26A	60	0.9	—
	2S11F		11.1	14	2	3.62(12) 45/0.32A	80	0.5	—
	2S14F		13.8	21	2	5.63(10) 70/0.32A	90	0.3	—
	2S7FG		6.8	5.2	2	1.27(16) 50/0.18(OFC)	50	1.5	—
	2S9FG		8.9	8.7	2	2.18(14) 41/0.26(OFC)	60	0.9	—
	2S11FG		11.1	14	2	3.62(12) 45/0.32(OFC)	80	0.5	—
	2S14FG		13.8	21	2	5.63(10) 70/0.32(OFC)	90	0.3	—

Insulation: polyethylene (orange, white) Jacket: PVC Dielectric strength: 500V AC/min.

\*Capacitance between conductors.

2S7F, 2S9F, 2S11F, 2S14F

● Special supple jacket designed for use in building conduits.

2S7FG, 2S9FG, 2S11FG, 2S14FG

● The G versions feature oxygen-free copper (OFC, JIS H3510) conductors.

Technical Note

Four-conductor Configuration Minimizes Noise

Because speaker cables are used to transmit comparatively high frequency signals, there is always the danger of electromagnetic noise affecting microphone cables that are used to transmit signals in the very delicate range. To overcome this problem, Canare has adopted a four-conductor configuration for all of its speaker cables. As shown in Fig. 2, the centers of the four conductors are positioned equidistantly in a configuration where the magnetic fields of adjoining cables are designed to cancel each other out. This distance factor significantly enhances the attenuation effect over that of the two-conductor configuration illustrated in Fig. 3. The result is a speaker cable design with a significantly lower noise emission factor.

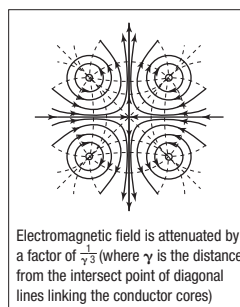

Fig.2 Electromagnetic Field Generated by Four-Conductor Cable

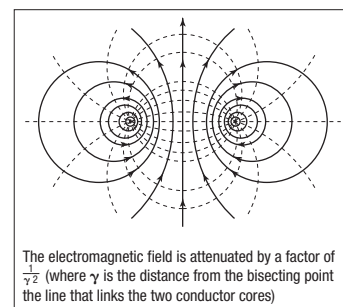

Fig.3 Electromagnetic Field Generated by Two-Conductor Cable

Selecting the Right Speaker Cable

The goal when using speaker cables is to keep them as short as possible. A rather lofty ideal, however, given the real demands of large facilities. Power amplifiers are in one location, power lines must be drawn and various other electrical systems for maintenance and safety are also in place. Economic considerations preclude splurging on the thicker, more expensive cabling. The following section describes an example for selecting speaker cables using the damping factor as the criterion.

The damping factor is the damping effect on the speaker that is determined by power amplifier performance. It is expressed using the formula shown below.

$$\text{damping factor} = \frac{\text{speaker impedance}}{\text{power amp. output impedance} + \text{speaker cable conductor resistance}}$$

The greater the damping factor the better the ability to control the speaker and create sharp, clear quality in low range output.

As the formula shows, a high conductor resistance in the speaker



cable, the lower the damping factor, which prevents even quality amplifiers from performing at their best.

When selecting cables, users should aim for a higher damping factor in the range of 20 to 50 for music facilities, and a lower factor of 10 to 20 for sports stadiums, where output is mainly speech. The table below shows the damping factors (DF) for various lengths of Canare cable for use as a quick reference.

Table 1 Values calculated assuming power amplifier output impedance is 0.05Ω

Model	Pair cond. resist. (Ω/100m) & cross-sec (mm <sup>2</sup> )	Cond. resist. (Ω/100m) for return path	Cable length/damping factor	
			DF=20	DF=50
4S6	1.87/1.0mm <sup>2</sup> AWG 17	3.7	9.5m	3.0m
4S8	0.75/2.5mm <sup>2</sup>	1.5	23.3	7.3
4S10F	0.54/3.5mm <sup>2</sup>	1.1	31.8	10.0
4S11	0.43/4.3mm <sup>2</sup>	11	40.2	12.6
4S12F	0.33/5.6mm <sup>2</sup>	10	53.0	16.7
4S14F	0.24/8.0mm <sup>2</sup>	9	74.5	23.4
4S18F	0.13/14.2mm <sup>2</sup>	6	129.6	40.7

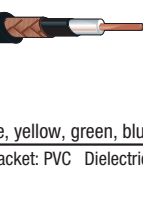
### OFC Line Cables

Type	Model	Sales units	Nom. O.D	Weight	Inner cond.		Insulation	Outer conductors	Electrical characteristics		
					Cross sec area (AWG) and cond. comp.	Nom. O.D			Shield construction and coverage	Chan. D.C.R.	Shield. D.C.R.
					mm <sup>2</sup> /(AWG) Q'ty/mm	mm	mm	mm/ends/carriers			
 <b>GS-4</b> Jacket color for GS-4: black GS-6: black, red, orange, yellow, green, blue	GS-4	200	4.0	2.7	0.39(22) 50/0.1(OFC)	0.82	1.82	Carbon plastic shield + 0.1 (OFC)/6/16 93%	4.7	3.1	—
	 <b>GS-6</b>	100 200	5.8	5.0	1.0(18) 127/0.1(OFC)	1.3	3.0	Carbon plastic shield + 0.1 (OFC)/8/16 92%	1.8	2.5	160

Insulation: polyethylene Jacket: PVC Dielectric strength: 500V AC/min.

\*Capacitance between conductor to shield.

#### GS-4, GS-6

- Outer conductor of fine 0.1mmØ OFC strands provide a highly flexible braided configuration. (See photographs A and B)

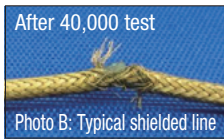

- Center conductor with 127 fine 0.1mmØ strands (50 for GS-4) increases durability.

\* Note:  
The GS-4 and GS-6 have a layer of carbon plastic shield underneath the braided shield (see Fig. 1) to block out noise. Shorting will result if this shield contacts the center conductor line, so special care must be taken when connecting the cable.

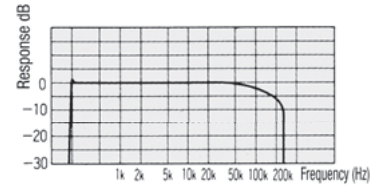
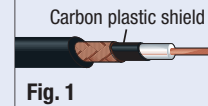



Fig. 2 Frequency Characteristics for GS-6 (100m, 100Ω → 1MΩ load)

### DMX Cable

Cable conforms to DMX512 standards for a use of stage lighting control.



Type	Model	Sales units	Nom. O.D	Weight	No. of cond.	Unit composition			Overall shield coverage (braid)	Cond. D.C.R.	Charac-teristic impedance
						Cross sec area (AWG) and cond. comp.	Twist pitch	Twist O.D.			
						mm <sup>2</sup> /(AWG) Q'ty/mm	mm	mm			
 <b>DMX203-2P</b> Jacket color: black, gray, white	DMX203-2P	100 200 500	7.9	7.9	4	0.35(22) 44/0.10TA	25	3.3	94%	5.9	110

Insulation: Cross-linked PE Jacket: Frame retardant PVC Dielectric strength: 500V AC/min.

#### DMX203-2P

- PE rod ensures consistent 110Ω impedance with large or small bends in cable during installation.
- Ideal for Neutrik NC5 connectors.

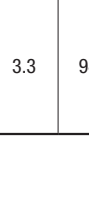
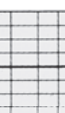
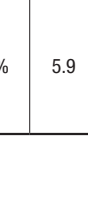
### RS422 Cables

Type	Cross-section view	Model	Sales units	Nom. O.D	Weight	Unit type	Unit composition			Overall Shield coverage	Conductor resistance	Charac-teristic impedance	Attenuation
							Cross sec area (AWG) and cond. comp.	Shield coverage	Unit O.D.				
							mm <sup>2</sup> /(AWG) Q'ty/mm	%	mm				
 <b>A2C3</b> Jacket color: black		A2C3	100 200 500	6.5	5.2	A	0.09(28) 7/0.127TA	90% Spiral shield	2.5	—	25.2	110	—
						C	0.22(24) 11/0.16TA	—	1.24				
 <b>A2C3-SS</b> Jacket color: black		A2C3-SS	100 200 500	7.0	7.2	A	0.09(28) 7/0.127TA	90% Spiral shield	2.5	91% Spiral shield	25.2	110	—
						C	0.22(24) 11/0.16TA	—	1.24				

Insulation: Cross-linked foam PE Jacket: Frame retardant PVC Dielectric strength: 500V AC/min.

#### A2C3



- Short distance version of the RS422 class cables.
- Irradiated foam core PE used for the insulation in the digital signal unit.

#### A2C3-SS

- Created by adding an overall spiral shield to the A2C3 to heighten shielding performance.

## Ethernet Cables

### Category 6 Cables

Type	Model	Shield type	Sales units	Nom. O.D	Weight	Conductors		Impedance	Insertion loss
						Cross sec. area & composition	DCR		
						m	mm		
 Jacket color: black, light blue	<b>RJC6-4P-F</b>	Overall foil (F/UTP)	100 200	7.0	5.0	0.22 (24) 1/0.54A	9.4	100	32.8 @250MHz
 Jacket color: black, gray	<b>RJC6-4P+</b>	N/A (U/UTP)	305	6.1	4.0	0.23 (23) 1/0.55A	8.2	100	32.8 @250MHz

Insulation: polyethylene, Jacket: PVC Dielectric strength: 350V AC/min.

#### RJC6-4P-F

- Standard CAT6 STP (F/UTP) cable
- 100% overall foil shield reject EMI.
- Solid conductor
- Length markings on the cable jacket
- Drain wire included.

#### RJC6-4P+

- Standard CAT6 UTP cable
- Solid conductor
- Length markings on the cable jacket
- UL 444 type CM
- Packaged in REELEX\* tangle-free cable dispenser

\*REELEX is the registered trademark of REELEX Packaging Solutions, Inc.

### Category 5e Cable

Type	Model	Shield type	Sales units	Nom. O.D	Weight	Conductors		Impedance	Insertion loss
						Cross sec. area & composition	DCR		
						m	mm		
 Jacket color: light blue	<b>RJC5E-4P+</b>	N/A (U/UTP)	305	5.0	3.0	0.20 (24) 1/0.50A	9.4	100	22.0 @100MHz

Insulation: polyethylene, Jacket: PVC Dielectric strength: 350V AC/min.



#### RJC5E-4P+

- Standard CAT5e UTP cable
- Solid conductor
- Length markings on the cable jacket

- UL 444 type CM
- Packaged in REELEX\* tangle-free cable dispenser

\*REELEX is the registered trademark of REELEX Packaging Solutions, Inc.

### Flex and Rugged Category 5e Cables

Type	Model	Shield type	Sales units	Nom. O.D	Weight	Conductors		Impedance	Insertion loss
						Cross sec. area & composition	DCR		
						m	mm		
 Jacket color: black	<b>RJC5ES-4P-BS</b>	Overall braid (S/UTP)	100 200	6.7	6.1	0.22(24) 7/0.20A	9.5	100	44.0 @100MHz
 Jacket color: black	<b>RJC5E-4P-WJ</b>	N/A (U/UTP)	100 200	7.4	5.4	0.22(24) 1/0.53A	8.8	100	22.0 @100MHz

Insulation: polyethylene (RJC5ES-4P-BS: Cross-linked polyethylene.) Jacket: PVC Dielectric strength: 350V AC/min.

#### RJC5ES-4P-BS

- Flexible and durable CAT5e STP cable for short distance.
- Stranded conductor and a overall braided shield
- Superior flexibility for easy routing and repeated bending

**Note:** Maximum allowed length of RJC5ES-4P-BS is 50m.

#### RJC5E-4P-WJ



- Rugged CAT5e UTP cable
- Solid conductor and double jacket
- Rugged and flexible double jacket offers easy routing.



75Ω Coaxial Cables

A wide variety of 75Ω coaxial cables support full-range of video formats. Our cutting-edge Super Low Loss Coax and Low Loss Coax are ideal for 3G-SDI/HD-SDI distribution.

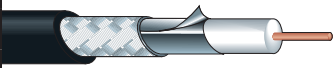
■ Super Low Loss Coax (Highly-Foamed PE Insulation)

Type	Model	Sales units	Nom. O.D	Weight	Inner cond		Insulation	Outer conductors	Inner cond. resistance	Outer cond. resistance	Static capacity	Charac-teristic impedance	Attenu-ation
					Conductor comp.	O.D.							
					m	mm	kg/100m	(AWG) Q'ty/mm	mm	mm	mm/ends/carriers	Ω/km	Ω/km
	L-2.5CHD	100 200	4.2	2.6	(23) 1/0.59A	0.59	2.59	0.12TA/7/16 (95%)	66.9	16.9	53	75	30.2
	L-4CHD		6.1	5.2	(20) 1/0.82A	0.82	3.68	0.14TA/8/16 (95%)	36.4	11.4	53	75	21.3
	L-4.5CHD		7.0	6.2	(18) 1/1.02A	1.02	4.57	0.14TA/6/24 (91%)	23.3	9.9	53	75	17.4
	L-5CHD		7.7	7.4	(17) 1/1.20A	1.20	4.9	0.14TA/7/24 (93%)	16.1	8.2	50	75	15.6
	L-6CHD		8.9	10	(15) 1/1.50A	1.50	6.1	0.14TA/8/24 (92%)	10.3	7.7	50	75	12.9
	L-7CHD		10.2	13	(13) 1/1.80A	1.80	7.3	0.16TA/8/24 (92%)	7.1	6.1	50	75	10.9
	L-8CHD		11.1	14	(12) 1/2.10A	2.10	8.2	0.16TA/8/24 (89%)	5.8	6.3	50	75	9.6
Jacket colors: black, red, yellow, green, blue and others.													
	L-2.5CHLT	100 200	4.2	1.8	(23) 1/0.59A	0.59	2.59	0.14TCCA/6/16 (95%)	66.9	21.5	53	75	30.2
Jacket colors: black, red, yellow, green, blue and others.													

Jacket: PVC Dielectric strength: 1000V AC/min.

L-CHD Series

- Best suited to 3G-SDI/HD-SDI transmission.
- Highly-foamed PE insulation allows further improvement in the attenuation characteristics.
- Multi-layer insulation in which to each layer is given a different foaming ratio is used to increase strength.
- High-density tinned copper braided shield with aluminum foil brings excellent shielding.
- Solid conductor
- Flame resistance UL 1666 Riser (excluding L-6CHD, L-7CHD, and L-8CHD).

Note 1: Designed for fixed installation, and do not tolerate repeated bending or external pressure well.



Note 2: Cable strippers (TS100 series) cannot be used for L-CHD series other than L-2.5CHD.

Note 3: L-2.5CHLT has less connection strength with the connector BCP-B25HD compared with L-2.5CHD.

L-2.5CHLT

- Ideal for an O.B. van installation.
- Tinned copper-clad aluminum (CCA) braided shield brings an advantage in weight-saving.
- 30% lighter than L-2.5CHD, yet the same attenuation.
- Space-saving slim design: O.D. 4.2 mm
- High-density braided shield with aluminum foil
- Highly-foamed PE insulation
- Solid conductor

■ Low Loss Coax for Mobile (Highly-Foamed/Foamed PE Insulation)

Type	Model	Sales units	Nom. O.D	Weight	Inner cond		Insulation	Outer conductors	Electrical characteristics			Charac-teristic impedance	Attenuation
					Conductor comp.	O.D.			Shield inner/outer coverage & comp.	Inner cond. re-sistance	Outer cond. re-sistance		
					m	mm	kg/100m	(AWG) Q'ty/mm				mm	mm
	L-4.5CHWS	100 200	7.2	6.6	(18) 7/0.34A	1.02	4.57	0.10A/8/24 (93%) 0.10A/9/24 (95%)	3.3	0.8	53	75	22.8
L-4.5CHWS Jacket color: black and others													
	L-3CFW	100 200 1000	5.8	5.1	(22) 1/0.65A	0.65	3.1	0.12A/5/24 (94%) 0.12A/6/24 (94%)	5.5	0.7	55	75	33.1
L-3CFW Jacket colors: black, red, green and others	L-5CFW		7.7	8.1	(18) 1/1.05A	1.05	5.0	0.12A/7/24 (93%) 0.12A/9/24 (96%)	2.3	0.5	55	75	19.4

Jacket: PVC Dielectric strength: 1000V AC/min.

L-CHWS Series

- Flexible and durable: Best suited to mobile HD application.
- Designed for withstanding repeated bending.
- Stranded center conductor
- High-density double-braided shield
- Highly-foamed insulation

Note: Cable strippers (TS100 series) cannot be used.

L-CFW Series

- Suited to mobile HD application.
- Achieve a good balance between durability and transmission distance.
- Solid center conductor
- High-density double-braided shield
- Foamed insulation

Note: Cable strippers (TS100 series) cannot be used.

Low Loss Coax (Foamed PE Insulation)

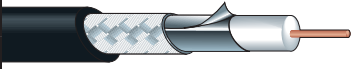
Type	Model	Sales units	Nom. O.D	Weight	Inner cond		Insulation	Outer conductors	Electrical characteristics			Characteristic impedance	Attenuation
					Conductor comp.	O.D.			O.D.	Shield coverage & comp.	Inner cond. re-istance		
		m	mm	kg/100m	(AWG) Q'ty/mm	mm	mm	mm/ends/carriers	Ω/100m	Ω/100m	pF/m	Ω	dB/100m 750MHz
 <p><b>L-5CFB</b> Jacket colors for L-3CFB, L-4CFB, L-5CFB: red, yellow, green, blue, white, black Others: black</p>	L-2.5CFB	100 200	4.0	2.4	(25) 1/0.50A	0.50	2.4	0.12TA/6/16 (92%)	9.3	2.0	55	75	37.0
	L-3CFB		5.5	4.0	(22) 1/0.65A	0.65	3.1	0.14TA/6/16 (91%)	5.5	1.6			29.1
	L-4CFB		6.1	4.9	(20) 1/0.80A	0.80	3.7	0.14TA/8/16 (93%)	3.6	1.1			23.6
	L-5CFB		7.7	7.3	(18) 1/1.05A	1.05	5.0	0.14TA/7/24 (93%)	2.3	0.8			17.7
	L-7CFB		10.2	13	(15) 1/1.50A	1.50	7.3	0.18TA/8/24 (95%)	1.0	0.5			13.4



Jacket: PVC Dielectric strength: 1000V AC/min.

L-CFB Series

- Foamed insulation; suited to HD video signals.
- High-density tinned copper braided shield with aluminum foil brings excellent shielding.

Note: Designed for fixed installation, and do not tolerate repeated bending or external pressure well.

Standard Coax (Solid PE Insulation)

Type	Model	Sales units	Nom. O.D	Weight	Inner cond		Insulation	Outer conductors	Electrical characteristics			Characteristic impedance	Attenuation
					Conductor comp.	O.D.			O.D.	Shield inner/outer coverage & comp.	Inner cond. re-istance		
		m	mm	kg/100m	(AWG) Q'ty/mm	mm	mm	mm/ends/carriers	Ω/100m	Ω/100m	pF/m	Ω	dB/100m (10MHz)
 <p><b>L-3C2VS</b> Jacket color L-3C2VS, L-5C2VS: brn, red, orn, yel, gm, blu, gry, wht, blk L-3C2V, L-5C2V: red, yel, gm, blu, gry wht, blk LV-61S: blu, red, yel, blk, wht, orn, brn, gry, gm, ppl Others: black</p>	L-1.5C2VS	200	2.9	1.3	(31) 7/0.09A	0.27	1.6	0.10A/5/16 (94%)	41.9	3.3	69	75	8.7
	L-3C2VS	100 200	5.5	4.5	(25) 7/0.18A	0.54	3.1	0.12A/7/16 (94%)	10.5	1.9	67		4.5
	LV-61S	153	6.1	5.0	(24) 7/0.20A	0.60	3.6	0.12A/6/24 (95%)	8.5	1.3			3.8
	L-5C2VS	100 200	7.4	6.8	(22) 7/0.26A	0.78	4.8	0.12A/7/24 (93%)	5.0	1.2	2.9		
	L-2.5C2V	100 200	4.0	2.4	(26) 1/0.40A	0.40	2.4	0.12TA/6/16 (94%)	19.2	2.1	69		5.2
	L-3C2V		5.4	4.3	(25) 1/0.50A	0.50	3.1	0.14TA/5/24 (97%)	9.3	1.2	67		4.1
	L-5C2V		7.4	7.2	(21) 1/0.80A	0.80	4.9	0.14TA/7/24 (94%)	3.6	0.8			2.5
 <p><b>L-3C2W</b> Jacket color: black</p>	L-3C2W	100 200	6.5	7.0	(25) 1/0.50A	0.50	3.1	0.14TA/5/24 (97%) 0.14TA/5/24 (93%)	9.3	0.6	67	75	4.1
	L-5C2W		8.3	11.0	(20) 1/0.80A	0.80	4.9	0.14TA/7/24 (94%) 0.14TA/7/24 (95%)	3.6	0.4			2.5
	LV-77S		153	7.7	9.0	(22) 7/0.26A	0.78	4.8	0.12A/7/24 (92%) 0.12A/8/24 (95%)	5.0			0.6

Jacket: PVC Dielectric strength: 1000V AC/min. \*100m/200m/500m/1000m

L-1.5C2VS, L-3C2VS, L-5C2VS, LV-61S

- Stranded center conductor ideal for locations requiring cable bending.

L-3C2W, L-5C2W, LV-77S

- Double-braided shield enhances shielding performance.

L-2.5C2V, L-3C2V, L-5C2V

- Solid center conductor

75Ω Triaxial Cables



Type	Model	Sales units	Nom. O.D	Weight	Inner cond.		Insulation 1	Outer cond.1	Insulation 2	Outer cond.2	Electrical characteristics			Characteristic impedance	Attenuation
					Cross sec. (AWG) & comp.	O.D.					O.D.	Braid coverage and comp.	O.D.		
		m	mm	kg/100m	mm <sup>2</sup> (AWG) Q'ty/mm	mm	mm	mm/ends/carriers	mm	mm/ends/carriers	Ω/100m	Ω/100m	pF/m	Ω	dB/100m (10MHz)
 <p><b>L-5CFTX</b> Jacket colors: black, red, green</p>	L-5CFTX	100 200	8.8	12.0	0.79(19) 1/1.0A	1.0	4.8	0.14A/6/24 (91%)	6.4	0.16A/8/24 (95%)	2.3	—	55	75	2.2
	L-4CFTX		9.1	10.5	0.50(20) 1/0.80A	0.80	3.7	0.14A/7/16 (93%)	5.5	0.14A/7/24 (94%)	3.64	—	55	75	3.0
	L-7CFTX	100 200 500	11.0	15.4	1.54(16) 1/1.40A	1.40	6.5	0.14A/8/24 (93%)	8.7	0.14A/8/24 (88%)	1.18	—	55	75	1.7
	10CFTX-SC		14.5	27.0	3.01(13) 7/0.74A	2.22	9.6	0.14A/10/24 (95%)	11.4	0.16A/10/24 (94%)	0.62	—	55	75	1.1

Insulation: 1: foamed PE, 2: polyethylene Dielectric strength: 1000V AC/min.

- Abrasion-resistance PVC jacket.

### 75Ω Multichannel Coaxial Cables

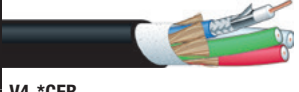
#### Low Loss Multichannel Coax (Foamed PE Insulation)

Type	Model	No. of ch.	Sales units	Nom. O.D	Weight	Unit composition				Electrical characteristics					
						Inner cond.		Insulation	Outer cond.		Unit O.D.	Inner cond. resistance	Outer cond. resistance	Characteristic impedance	Attenuation
						Cross sec. area	tion conductor comp.		O.D.	O.D.					
m	mm	kg/100m	mm <sup>2</sup> /(AWG) Q'ty/mm	mm	mm	%	mm	Ω/100m	Ω/100m	Ω	dB/100m (750MHz)				
 <b>V4-*CFB</b> Jacket color: black Insulation: Foamed PE	V3-3CFB	3	100 500	11.5	14	Refer to L-3CFB (P61)				4.4	5.6	1.6	75	29.1	
	V4-3CFB	4		13.0	19	Refer to L-4CFB (P61)				5.0	3.7	1.0	75	24.3	
	V5-3CFB	5		14.2	23	Refer to L-5CFB (P61)				6.5	2.3	0.8	75	17.7	
	V3-4CFB	3		12.9	18	Refer to L-3CFW (P60)				4.9	5.6	0.7	75	33.1	
	V4-4CFB	4		14.4	23	Refer to L-4CFW (P60)				7.0	2.4	0.5	75	19.4	
	V5-4CFB	5		16.1	29										
	V3-5CFB	3		17.1	29										
	V4-5CFB	4		18.8	36										
 <b>V4-2.5CHW</b> Jacket color: black Insulation: Highly-foamed PE	V4-2.5CHW	4	100 500	13.0	21	0.27 (23) 1/0.59A	0.59	2.59	0.10TA/8/16 (95%) 0.10TA/9/16 (94%)	4.2	6.7	1	75	35.7	
	 <b>V5-*CFW</b> Jacket color: black Insulation: Foamed PE	V3-3CFW	3	100 500	13.0	22	Refer to L-3CFW (P60)				4.9	5.6	0.7	75	33.1
V4-3CFW		4	14.6		28	Refer to L-4CFW (P60)				7.0	2.4	0.5	75	19.4	
V5-3CFW		5	16.2		34										
V3-5CFW		3	18.4		36										
V4-5CFW		4	20.4		47										
V5-5CFW	5	22.4	58												

Jacket PVC Dielectric strength: 1000V AC/min.

#### V-CFB Series

- Bundled thinner jacket type of Canare L-CFB Series: solid conductor and foamed PE insulation wrapped with aluminum foil.
- Excellent low attenuation performance will fit for digital video in fixed installations.
- Distinguishable RGB color-coded.

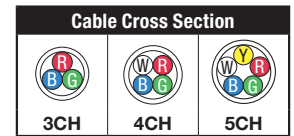

#### V4-2.5CHW, V-CFW Series

- Developed for digital video mobile application with flexible double braided shield.

Note: Cable strippers (TS100 series) cannot be used for V4-2.5CHW and V-CFW series.

#### Standard Multichannel Coax (Solid PE Insulation)

Type	Model	No. of ch.	Sales units	Nom. O.D	Weight	Unit composition				Electrical characteristics					
						Inner cond.		Insulation	Outer cond.		Unit O.D.	Inner cond. resistance	Outer cond. resistance	Characteristic impedance	Attenuation
						Cross sec. area	tion conductor comp.		O.D.	O.D.					
m	mm	kg/100m	mm <sup>2</sup> /(AWG) Q'ty/mm	mm	mm	%	mm	Ω/100m	Ω/100m	Ω	dB/100m (10Mhz)				
 <b>V4-*C</b> Jacket color: black Insulation: Solid PE	V3-1.5C	3	100 500	7.4	7.3	Refer to L-1.5C2VS (P61)				2.6	42.3	3.3	75	8.7	
	V4-1.5C	4		8.4	9.4	Refer to L-1.5C2VS (P61)				2.6	42.3	3.3	75	8.7	
	V5-1.5C	5		9.2	11	Refer to L-1.5C2VS (P61)				2.6	42.3	3.3	75	8.7	
	V3-3C	3		11.5	15	Refer to L-3C2VS (P61)				4.4	10.6	1.1	75	4.5	
	V4-3C	4		13.0	20	0.18 (25) 7/0.18A	0.54	3.1	0.14A/5/24 (97%)	4.4	10.6	1.1	75	4.5	
	V5-3C	5		14.2	24	Refer to L-3C2VS (P61)				6.0	5.1	1.2	75	2.9	
	V3-5C	3		15.5	26	Refer to L-3C2VS (P61)				6.0	5.1	1.2	75	2.9	
	V4-5C	4		17.1	33	Refer to L-3C2VS (P61)				6.0	5.1	1.2	75	2.9	
V5-5C	5	19.2	39	Refer to L-3C2VS (P61)				6.0	5.1	1.2	75	2.9			

Jacket PVC Dielectric strength: 1000V AC/min.





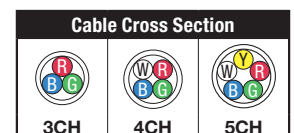

#### V-C Series

- Our long-selling multichannel coax, ideal for component video.
- Bundled thinner jacket type of Canare L-C2VS series: flexible stranded conductor and solid PE insulation.
- Distinguishable RGB color-coded.



**A/V Composite Cables**

Used for linking audio video equipment and as extensions for video cameras.

Type	Model	Sales units	Nom. O.D	Weight	Unit type V: Video A: Audio C: Control line	Unit composition			Electrical characteristics	
						Cross sec. area Conductor comp.	Shield coverage	Unit O.D.	Characteristic impedance	Attenuation
						mm <sup>2</sup> /(AWG) Q'ty/mm	%	mm	Ω	dB/100m (10MHz)
 <b>A2V1</b> Jacket color: black	 <b>A2V1</b>	100 200	9.7	11	V Video 3C-2V×1	0.20(24) 1/0.5A	97% (braid)	4.4	75	4.1
	A Audio L-2B2AT×2				Refer to L-2B2AT	Aluminum foil shield	3.2	—	—	
	 <b>A2V2-L</b>		11.0	16	V Video 3C-2V×2	0.20(24) 1/0.5A	97% (braid)	4.4	75	4.1
	A Audio L-2B2AT×2				Refer to L-2B2AT	Aluminum foil shield	3.2	—	—	
	C Control lines 0.2mm <sup>2</sup> ×4				0.20(24) 18/0.12A	—	1.3	—	—	
	 <b>A2V1B</b>		11.1	13	V Video 3C-2VS×1	0.18(25) 7/0.18A	97% (braid)	4.4	75	4.5
A Audio 4E3 Unit×2	0.08(29) 7/0.12A	93% (braid)			3.4	—	—			
 <b>A2V2B</b>	12.3	17	V Video 3C-2VS×2	0.18(25) 7/0.18A	97% (braid)	4.4	75	4.5		
A Audio 4E3 Unit×2			0.08(29) 7/0.12A	93% (braid)	3.4	—	—			
 <b>A3V2-FB</b>	12.4	17	V Video 3CFB Unit×2	0.33(22) 1/0.65A	91% (braid) + Aluminum foil	4.4	75	3.7		
A Audio L-2B2AT×3			Refer to L-2B2AT	Aluminum foil shield	3.2	—	—			

Jacket: PVC Dielectric strength: 500V AC/min.

**A2V1, A2V2-L**

- Designed for fixed installation.



**A2V1B, A2V2B**

- Ideal for locations requiring cable bending.

**A3V2-FB**

- 3 balanced audio channels and 2 video coax channels for ENG, EFP, or OB applications.

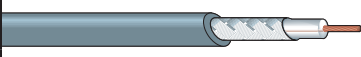
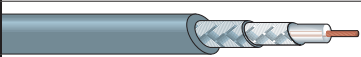
**50Ω Coaxial Cables**

Type	Model	Sales units	Nom. O.D	Weight	Inner cond		Insulation	Outer conductors	Electrical characteristics			Characteristic impedance	Attenuation
					Cross sec. (AWG) & comp.	O.D.			Inner cond. re-sistance	Outer cond. re-sistance	Static capacity		
					mm <sup>2</sup> /(AWG) Q'ty/mm	mm			Ω/100m	Ω/100m	pF/m		
 <b>L-3D2V</b> Jacket color: gray	<b>L-3D2V</b>	100 200	5.3	4.5	0.56(20) 7/0.32A	0.96	3.0	0.14TA/5/24 (98%)	3.3	1.2	100	50	4.5
	<b>L-5D2V</b>		7.3	7.9	1.54(15) 1/1.40A	1.40	4.8	0.14TA/7/24 (95%)	1.2	0.8			2.5
 <b>L-3D2W</b> Jacket color: gray	<b>L-3D2W</b>	100 200	6.4	7.3	0.56(20) 7/0.32A	0.96	3.0	0.14TA/5/24 (98%) 0.14TA/5/24 (96%)	3.3	0.6	100	50	4.5
	<b>L-5D2W</b>		8.0	11.0	1.54(15) 1/1.40A	1.40	4.8	0.14TA/7/24 (95%) 0.14TA/7/24 (96%)	1.2	0.4			2.5
 <b>L-5DFB</b> Jacket color: black	<b>L-5DFB</b>	100 200	7.6	8.5	2.55(13) 1/1.80A	1.80	5.0	0.14TA/6/24 (90%)	0.7	1.1	84		2.5

Insulation: polyethylene Jacket: PVC Dielectric strength 1000V AC/min.

**L-3D2V, L-3D2W, L-5D2V and L-5D2W**

- Tinned annealed copper used on outer conductors.

**L-5DFB**

- Low-loss foamed PE used for insulation.



# Technical Note

## Many types of video coax. What're the differences and how select?

In brief, there are three of essential factors: 1) center conductor, 2) insulation, and 3) shield. Each factor has its advantage and disadvantage as described below:

- 1) Center Conductor: two types existing, "Solid" and "Stranded". Stranded conductor is more flexible and therefore the best choice for mobile and stage use.
- 2) Insulation: includes "Solid", "Foamed", and "Highly-foamed" types. Foamed and highly-foamed insulation would perform better attenuation, compared to the solid type thus they are often selected for hi-def video. However, since foamed and high-foamed insulation contain the air physically, they are weak to external pressure. You should pay attention to where and how the cables are installed.
- 3) Shield: we have "Braided" and "Braided with aluminum foil" type. Braided shields include single, double, or triple layers as well as bare copper or tinned copper. Braided with aluminum foil offers perfect screening, but they are not suitable for repeated bending and mobile applications due to the foil's lack of strength. In that case, it's better to choose "Braided".

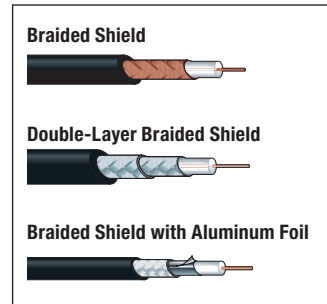

## What is Propagation Delay?

Propagation delay refers to the time required for a signal to be transmitted from one end of connection to another. In the case of cable transmission, this greatly depends on the materials and construction of the actual cable, and large differences in delay can cause transmission errors if they exceed the receiver delay tolerance.

The following table shows the differences in coaxial cable propagation delay time relative to the insulation type.

### Propagation Delay Caused by Coaxial Cable Insulation (reference)

Insulation	Propagation Delay
Solid PE	5.0 ns/m
Foamed PE	4.2 ns/m
Highly-Foamed PE	3.7 ns/m

### Maximum Transmission Distance by Video Format (reference)

Standard	SMPTE ST 259	ITU-R BT. 601	SMPTE ST 259	SMPTE ST 259	SMPTE ST 344	SMPTE ST 292	SMPTE ST 424
Video Format	Composite NTSC	Composite PAL	Component 4:2:2	Component 4:2:2 16x9	SDI	HD-SDI	3G-SDI
Bit Rate	143 Mb/s	177 Mb/s	270 Mb/s	360 Mb/s	540 Mb/s	1.5 Gb/s	3.0 Gb/s
Model	m	m	m	m	m	m	m
L-2.5CFB	265	242	199	172	139	54	55 (36)
L-2.5CHD	314	287	237	206	168	66	69 (46)
L-2.5CHLT	314	287	237	206	168	66	69 (46)
L-3CFB	344	314	257	222	179	68	69 (46)
L-4CFB	422	314	315	272	220	84	86 (57)
L-4CHD	447	410	337	294	238	93	98 (65)
L-5CFB	563	513	420	364	294	112	114 (76)
L-4.5CHD	551	504	415	361	293	115	119 (79)
L-5CHD	614	562	464	403	327	128	133 (88)
L-6CHD	766	700	575	499	403	154	158 (105)
L-7CHD	902	824	678	589	476	184	188 (125)
L-8CHD	1035	945	777	674	544	208	212 (141)
V4-2.5CHW	288	258	208	178	144	56	57 (38)
L-3CFW	319	288	230	197	158	60	60 (40)
L-4.5CHWS	447	405	322	280	225	87	90 (60)
L-5CFW	535	483	384	333	267	103	105 (70)

The above values are based on SMPTE standards. Our criteria is as follows:  
 ST 292 & 424M : The listed coaxial cable's attenuation value does not exceed 20 dB loss at one-half the clock frequency (bit rate).  
 ST 424 & others : The listed coaxial cable's attenuation value does not exceed 30 dB loss at one-half the clock frequency (bit rate).  
 Recommended margin: 2 or 3 dB. See page 65 for the nominal attenuation.

(SMPTE 424M)

# Nominal Attenuation

## Nominal Attenuation

dB/100m

Model	Frequency		SMPTE 259M Composite NTSC 72.0MHz	ITU-R BT.601 Composite PAL 88.0MHz	SMPTE 259M Composite 4:2:2 135MHz	SMPTE 259M Composite 4:2:2 16x9 180MHz	SMPTE 344M 540Mb/s SDI 270MHz	440MHz	SMPTE 292M HD-SDI 750MHz	1.3GHz	SMPTE ST 424 3G-SDI 1.5GHz	2.4GHz	3GHz	6GHz
	10MHz	30MHz												
L-1.5C2VS/V*-1.5C	8.7	15.2	23.8	26.4	32.9	38.1	47.1	60.8	—	—	—	—	—	—
L-2.5CFB	4.8	7.6	11.3	12.4	15.1	17.4	21.5	27.8	37.0	50.0	54.1	70.5	80.2	121.8
L-2.5CHD/L-2.5CHLT	4.1	6.5	9.5	10.4	12.6	14.5	17.8	22.9	30.2	40.0	43.1	55.1	62.0	91.7
V4-2.5CHW	3.8	6.7	10.4	11.6	14.4	16.8	20.7	26.9	35.7	48.3	52.3	68.1	77.4	115.9
L-3C2V/L-3C2W	4.1	7.2	11.3	12.5	15.7	18.3	22.8	29.7	40.0	—	—	—	—	—
L-3C2VS/V*-3C	4.5	7.9	12.4	13.7	17.2	20.0	24.8	32.3	43.2	—	—	—	—	—
L-3CFB/V*-3CFB	3.7	5.9	8.7	9.5	11.7	13.5	16.7	21.7	29.1	39.6	43.0	56.5	64.5	93.5
L-3CFW/V*-3CFW	3.4	5.9	9.4	10.4	13.0	15.2	18.9	24.6	33.1	45.4	49.4	65.3	74.8	114.2
L-4CFB	3.0	4.8	7.1	7.8	9.5	11.0	13.6	17.7	23.6	31.9	34.6	45.2	51.5	76.9
V*-4CFB	3.0	4.9	7.2	7.9	9.7	11.2	13.9	18.1	24.3	33.2	36.0	47.5	54.3	83.8
L-4CHD	2.9	4.6	6.7	7.3	8.9	10.2	12.6	16.1	21.3	28.4	30.6	39.3	44.3	65.1
L-4.5CHD	2.3	3.7	5.4	6.0	7.2	8.3	10.2	13.2	17.4	23.2	25.1	32.3	36.5	53.6
L-4.5CHWS	2.5	4.3	6.7	7.4	9.3	10.7	13.3	17.2	22.8	30.8	33.3	43.3	49.1	79.3
L-5C2V/L-5C2W	2.5	4.5	7.1	7.9	9.9	11.6	14.4	19.0	25.7	35.6	38.9	52.0	59.9	—
L-5C2VS/V*-5C	2.9	5.2	8.1	9.0	11.4	13.3	16.5	21.7	29.2	40.5	44.1	58.7	67.5	—
L-5CFB/V*-5CFB	2.2	3.6	5.3	5.8	7.1	8.2	10.2	13.2	17.7	24.1	26.1	34.3	39.1	58.6
L-5CFW/V*-5CFW	2.1	3.6	5.6	6.2	7.8	9.0	11.2	14.5	19.4	26.2	28.4	37.1	42.2	70.5
L-5CHD	2.1	3.3	4.9	5.3	6.5	7.4	9.1	11.8	15.6	20.8	22.5	29.0	32.8	48.7
L-6CHD	1.7	2.7	3.9	4.3	5.2	6.0	7.4	9.7	12.9	17.5	19.0	24.8	28.3	42.0
L-7CFB	1.6	2.5	3.8	4.2	5.1	6.0	7.5	9.8	13.4	18.8	20.5	27.6	32.0	53.6
L-7CHD	1.4	2.3	3.3	3.6	4.4	5.1	6.3	8.2	10.9	14.7	15.9	20.7	23.5	34.4
L-8CHD	1.2	2.0	2.9	3.2	3.9	4.4	5.5	7.2	9.6	13.0	14.1	18.5	21.1	30.4
LV-61S	3.8	6.6	10.4	11.6	14.5	16.9	20.9	27.3	36.6	49.9	54.2	71.5	81.7	126.0
LV-77S	2.9	5.2	8.1	9.0	11.3	13.1	16.3	21.3	28.6	—	—	—	—	—
L-3D2V/L-3D2W	4.5	8.0	12.6	14.1	17.7	20.7	25.9	34.1	46.4	64.5	70.4	94.6	109.2	—
L-5D2V/L-5D2W	2.5	4.4	7.0	7.7	9.7	11.4	14.2	18.7	25.5	35.4	38.6	51.8	59.7	—
L-5DFB	2.5	3.9	5.7	6.2	7.5	8.6	10.8	14.1	19.0	26.1	28.4	37.7	43.2	—

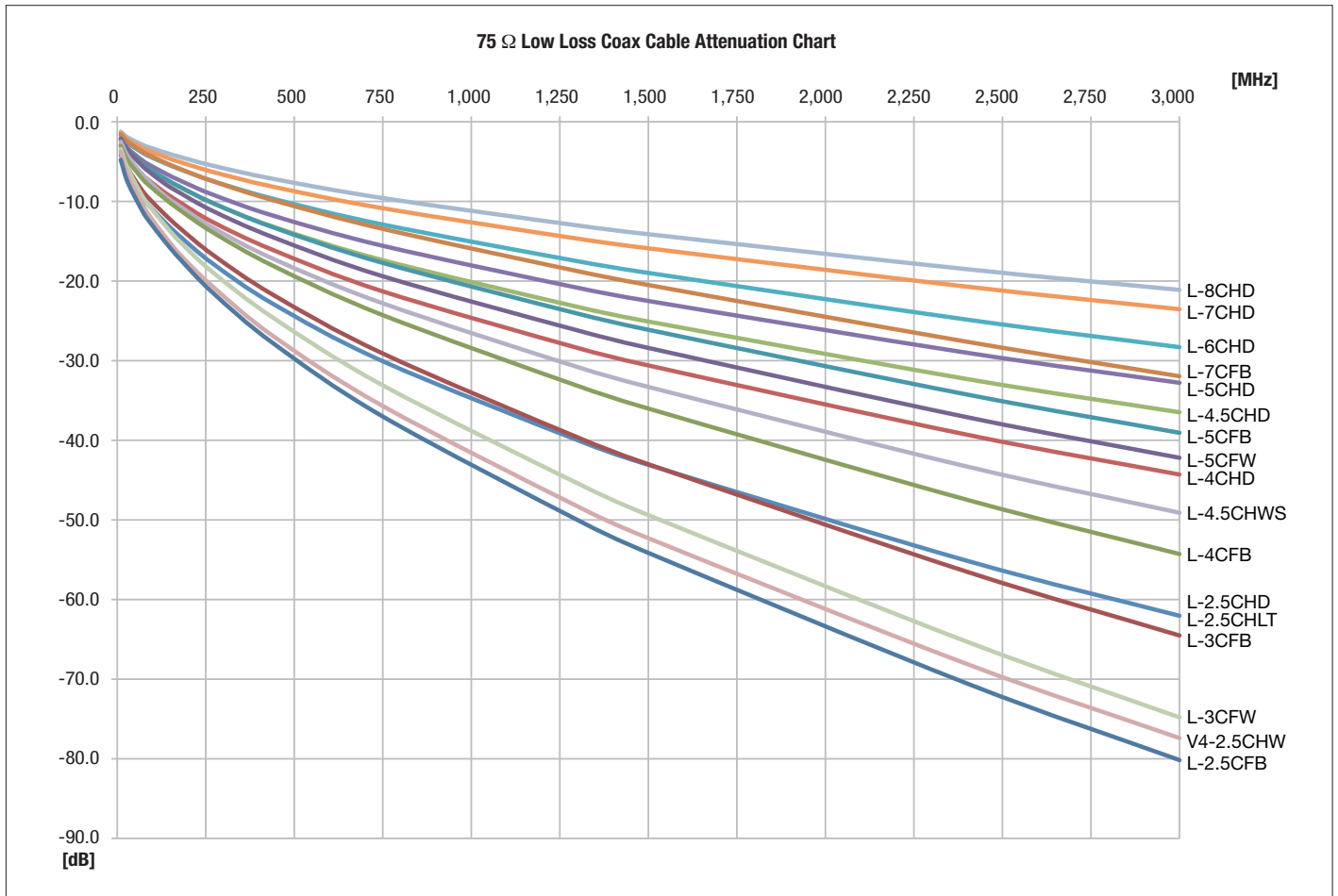

### 75Ω Video Patchbays

3G-ready HD-SDI video patchbays featuring Canare's uniquely-developed rotary switches.

Model	Panel Size	Loaded Video Jacks
20DV	1RU	20 x DVJB-W
20DVS	1RU	20 x DVJB-S
20DV-2U	2RU	20 x DVJB-W
20DVS-2U	2RU	20 x DVJB-S
24DV	1RU	24 x DVJB-W
24DVS	1RU	24 x DVJB-S
24DV-2U	2RU	24 x DVJB-W
24DVS-2U	2RU	24 x DVJB-S
26DV	1RU	26 x DVJB-W
26DVS	1RU	26 x DVJB-S
26DV-2U	2RU	26 x DVJB-W
26DVS-2U	2RU	26 x DVJB-S

\*Colors other than black are available on custom-made basis. (See page 69)

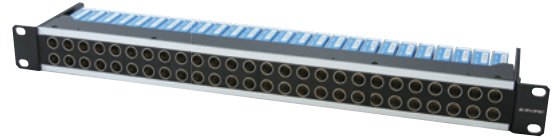

26DV

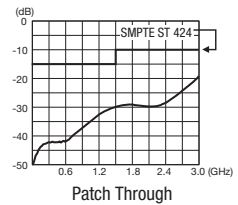
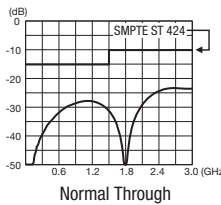
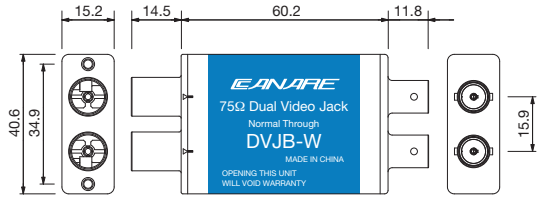

Return loss for DVJB-W

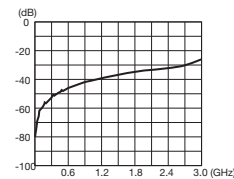

Isolation

### 75Ω Dual Video Jacks

Model	Description
DVJB-W	Normal Through
DVJB-S	Straight Through
VJ-DC	Dust Cap for Video Jack (color: black 40pcs)

#### Key Features and Benefits

- Rotary switch has been improved for superior isolation.
- Also usable as digital audio patchbay.
- Can be recessed 25mm.
- Wide designation strip (2RU type).
- Lightweight aluminum alloy video jacks.

#### Return Loss & Isolation

Model	Return Loss			Isolation
	BNC-BNC: Normal Through	BNC-VIDEO: Patch Through	BNC-Self Termination	
DVJB-W		26dB or greater (~750MHz)		35dB or greater (~1.5GHz) 20dB or greater (~3.0GHz)
		20dB or greater (~2.4GHz)		
		10dB or greater (~3.0GHz)		
DVJB-S	N/A	26dB or greater (~750MHz)	26dB or greater (~750MHz)	35dB or greater (~1.5GHz) 20dB or greater (~3.0GHz)
		20dB or greater (~2.4GHz)	20dB or greater (~1.5GHz)	
		10dB or greater (~3.0GHz)	10dB or greater (~3.0GHz)	

## Technical Note

### Rotary Switch Technology and Signal Routing Chart

At the heart of the video jack is an independently-developed rotary switch which has been specially designed for use with high frequency signals. It features dual-contact construction for improved contact stability.



W Series (Normal Through)			
Video Port: No Patch		BNC Port: Signal thru as Arrowed	Signal routes between top and bottom BNC without the use of Video plugs.
Video Port: Patch Upper		BNC Port: Lower Terminated	Inserting a Video Patch Cord into front "upper" port automatically terminates signal path into the lower 75Ω load.
Video Port: Patch Lower		BNC Port: Upper Terminated	Inserting a Video Patch Cord into front "lower" port automatically terminates signal path into the upper 75Ω load.
Video Port: Patch Both		BNC Port: Signal thru as Arrowed	Inserting Video Patch Cords into both front ports inputs and/or outputs signal.

S Series (Straight Through)			
Video Port: No Patch		BNC Port: Both Signal Terminated	Two independent single jacks in a dual housing.
Video Port: Patch Upper		BNC Port: Lower Terminated	Inserting a Video Patch Cord into front "upper" port automatically terminates signal path into the lower 75Ω load.
Video Port: Patch Lower		BNC Port: Upper Terminated	Inserting a Video Patch Cord into front "lower" port automatically terminates signal path into the upper 75Ω load.
Video Port: Patch Both		BNC Port: Signal thru as Arrowed	Inserting Video Patch Cords into both front ports inputs and/or outputs signal.

## 75Ω Staggered Mid-size Video Patchbays

3G-ready mid-size video jacks allow for more efficient use of rack space.

Model	Panel Size	Loaded Video Jacks
32MD-ST	1RU	32 x MDVJ-STW
32MD-ST-S	1RU	32 x MDVJ-ST-S
32MD-ST-2U	2RU	32 x MDVJ-STW
32MD-ST-S-2U	2RU	32 x MDVJ-ST-S
32MD-ST-4U	4RU	96 x MDVJ-STW
32MD-ST-S-4U	4RU	96 x MDVJ-ST-S

\*Colors other than black are available on custom model basis except 4RU type (See page 69).

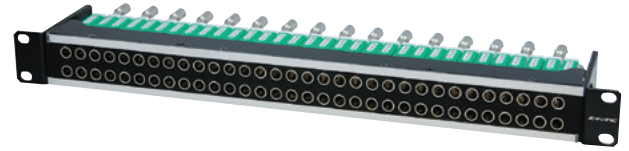

32MD-ST-S

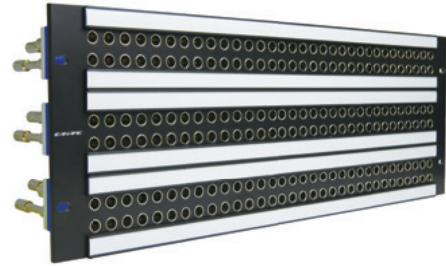
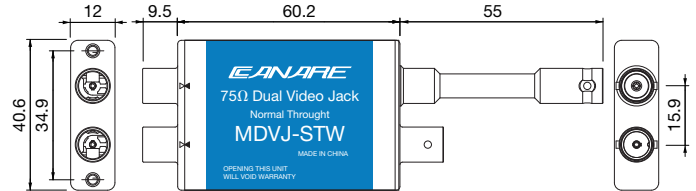

32MD-ST-4U

## 75Ω Staggered Mid-size Video Jacks

Model	Description
MDVJ-STW	Staggered Mid-size Video Jack, Normal Through
MDVJ-ST-S	Staggered Mid-size Video Jack, Straight Through
MVJ-DC	Dust cap for Mid-size video Jack (color: black 40pcs)

### Key Features and Benefits

- 32 channels of I/O into 1RU or 2RU, 96 channels of I/O into 4RU.
  - Rotary switch has been improved for superior isolation.
  - Can be recessed 25mm (1RU, 2RU type).
  - Wide designation strip (2RU, 4RU type).
  - Lightweight aluminum alloy video jacks.
  - Industry standard BNC plugs can be used.
- Note :** Be sure to use with Mini-Weco video plug.

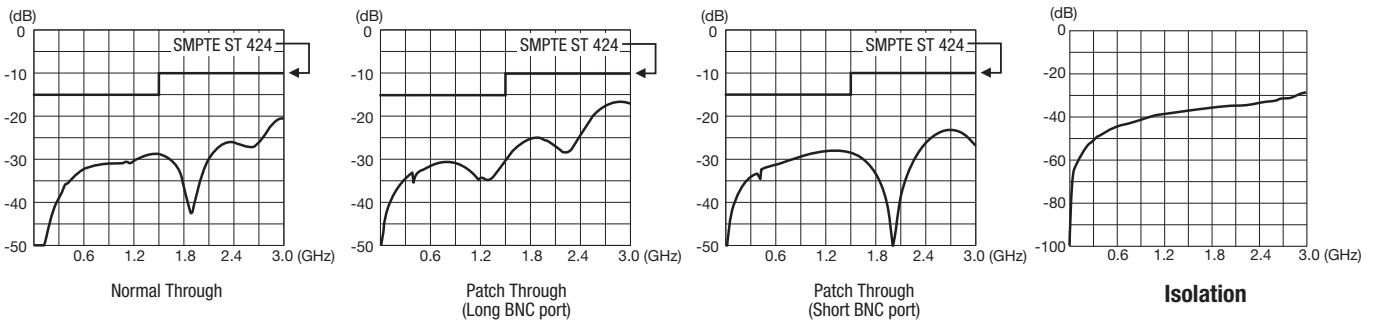

Return loss for MDVJ-STW

### Return Loss & Isolation

Model	Return Loss			Isolation
	BNC-BNC: Normal Through	BNC-VIDEO: Patch Through	BNC-Self Termination	
MDVJ-STW		26dB or greater (~750MHz)		35dB or greater (~1.5GHz) 20dB or greater (~3.0GHz)
		20dB or greater (~2.4GHz)		
		10dB or greater (~3.0GHz)		
MDVJ-ST-S	N/A	26dB or greater (~750MHz)	26dB or greater (~750MHz)	35dB or greater (~1.5GHz) 20dB or greater (~3.0GHz)
		20dB or greater (~2.4GHz)	20dB or greater (~1.5GHz)	
		10dB or greater (~3.0GHz)	10dB or greater (~3.0GHz)	



### Video Plug (W.E.Standard)

Model	Suitable Cable	Boot	Die Set
<b>VWP-C4A</b>	LV-61S, RG-59B/U, Belden 8241, 8279, 88241	CB04	TCD-451CA TCD-4CA

•Standard Package (20pcs)

- Gold-plated center contact resists deterioration over years of use.
- Solder center contact and crimp sleeve.

Be sure to use Canare crimping tool for installing connectors on cables.



**VWP-C4A**

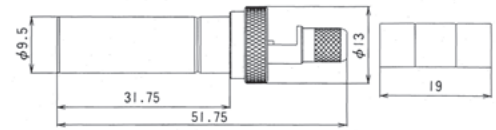

**VWP-C4A**



**Video Patch Cord**  
(see page 77)

### Mini-WECO Video Plug

Model	Suitable Cable	Boot	Die Set
<b>MVP-C4</b>	LV-61S, RG-59B/U, Belden 8241, 8279, 88241	CB25	TCD-451CA TCD-4CA

•Standard Package (20pcs)

- Return loss: 26 dB or greater (DC - 1.5GHz), 20dB or greater (DC - 2.4GHz).
- Gold-plated center contact resists deterioration over years of use.
- Solder center contact and crimp sleeve.

Be sure to use Canare crimping tool for installing connectors on cables.



**MVP-C4**

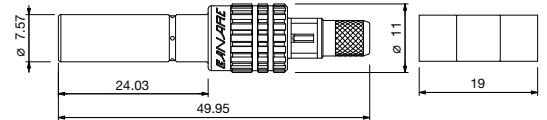

**MVP-C4**



**Mini-Weco Video Patch Cord**  
(see page 77)

### Video Conversion Connectors

Model	Description
<b>BCJ-VWP</b>	BNC (female) - Video plug (W.E.Standard)
<b>BCJ-MVP</b>	BNC (female) - Mini-WECO Video plug

•Standard Package: BCJ-VWP (1pcs), BCJ-MVP (10pcs)

Note: BCJ-MVP is recommended to use with Slim BNC plug.



**BCJ-VWP**

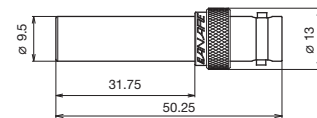

**BCJ-VWP**



**BCJ-MVP**

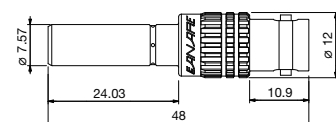

**BCJ-MVP**

## Ordering Information

### Standard Video Patchbays

26 DV S - 5 - 2U

Number of Video Jacks

20	20pcs
24	24pcs
26	26pcs

Circuit Type

Blank	Normal Through
S	Straight Through

Rack Unit (height)

Blank	1RU
2U	2RU

Panel Color

Blank	Black
1	Brown
2	Red
3	Orange
4	Yellow
5	Green
6	Blue
7	Purple
8	Gray
9	White

### Mid-size Video Patchbays

32 MD - ST S - 1 - 2U

Circuit Type

Blank	Normal Through
S	Straight Through

Rack Unit (height) & Number of Video Jacks

Blank	1RU, 32 Jacks
2U	2RU, 32 Jacks
4U	4RU, 96 Jacks

Panel Color

Blank	Black
1	Brown
2	Red
3	Orange
4	Yellow
5	Green
6	Blue
7	Purple
8	Gray
9	White

Note:

- 1) 4RU type is available in black color only
- 2) 4RU type can not be recessed.

### Designation Strip Dimensions

- 1RU: 426mm x 6.2mm
- 2RU: 420mm x 18.4mm
- 4RU: 431.8mm x 13.2mm

### 32MD-ST-2U

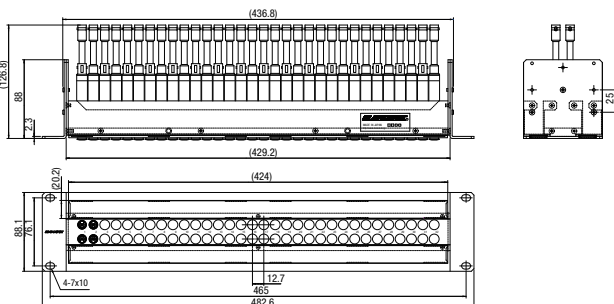

### 32MD-ST-4U

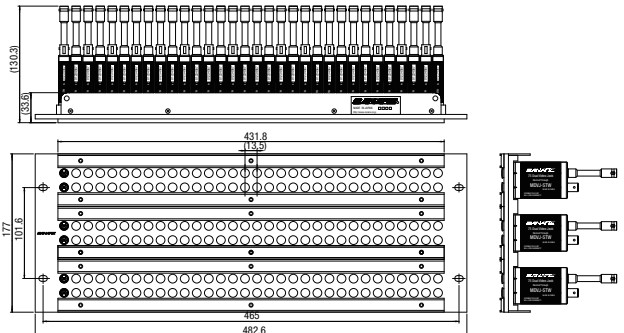

### 20DV (1RU)

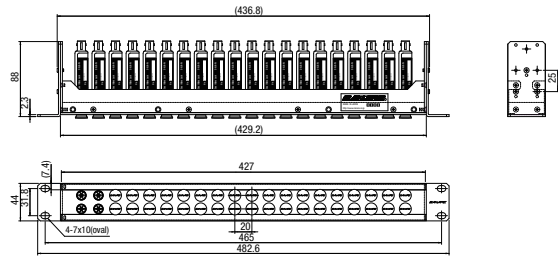

### 24DV (1RU)

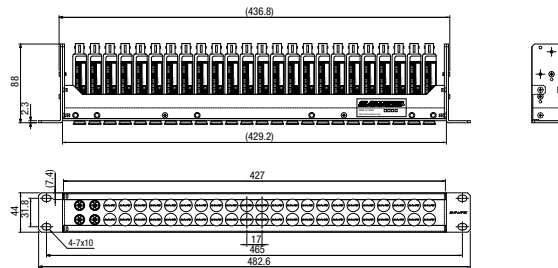

### 26DV-2U (2RU)

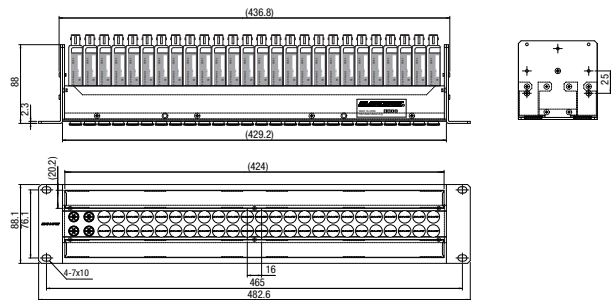

### 32MD-ST

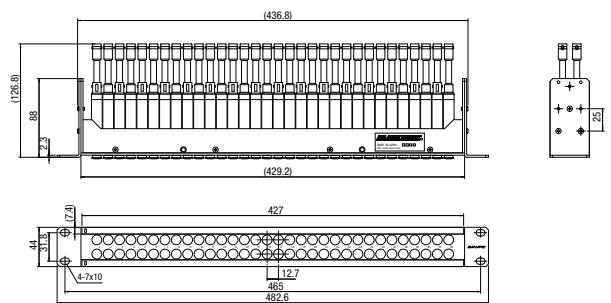

### Unloaded Video Jack Panels

Model	Panel Size	Description
VJ2-V20-1U-***	1RU	20ch (40 holes), for DVJB
VJ2-V20-2U-***	2RU	20ch (40 holes), for DVJB
VJ2-V24-1U-***	1RU	24ch (48 holes), for DVJB
VJ2-V24-2U-***	2RU	24ch (48 holes), for DVJB
VJ2-V26-1U-***	1RU	26ch (52 holes), for DVJB
VJ2-V26-2U-***	2RU	26ch (52 holes), for DVJB
MJ2-M32-1U-***	1RU	32ch (64 holes), for MDVJ
MJ2-M32-2U-***	2RU	32ch (64 holes), for MDVJ
VJ2-M32-4U	4RU	96ch (3 x 32ch, 192 holes), for MDVJ (Color: Black)

\*\*\* : Please see the following ordering information for complete model number.

### <Ordering Information>

Coding Ex. **VJ2 - V20 - 2U - BLK**

Panel Size

<b>1U</b>	1RU
<b>2U</b>	2RU
<b>4U</b>	4RU

Color Codes

<b>BLK</b>	Black
<b>BRN</b>	Brown
<b>RED</b>	Red
<b>ORG</b>	Orange
<b>YEL</b>	Yellow
<b>GRN</b>	Green
<b>BLU</b>	Blue
<b>PPL</b>	Purple
<b>GRY</b>	Gray
<b>WHT</b>	White

### VJ2-V24-1U-BLK

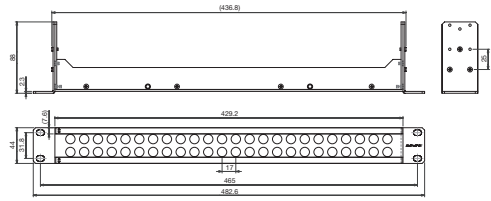

### MJ2-M32-2U-BLK

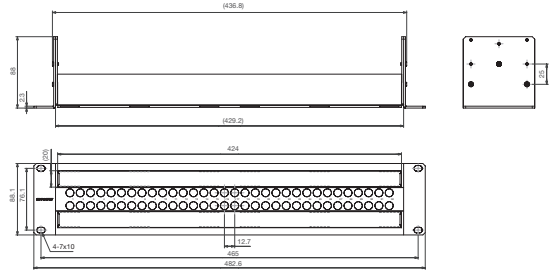

### VJ2-M32-4U

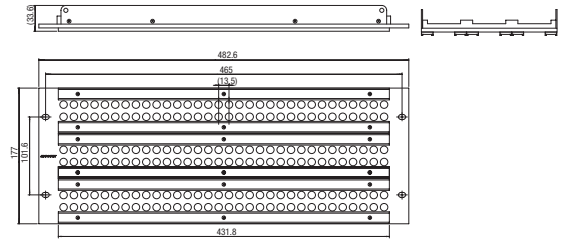

### RS422 Patchbays

Model	Panel Size	Connectors	
		Front Panel	Rear Panel
RS-422-1U-16	1RU	Bantam	D sub 9P(F)×16
RS-422-1U-24	1RU	Bantam	D sub 9P(F)×24
RS-422-2U-32	2RU	Bantam	D sub 9P(F)×32
RS-422-2U-48	2RU	Bantam	D sub 9P(F)×48

- The RS422 serial signal used for VTR remote applications can now be switched with Bantam patchbay ease.
- D sub screws are M2.6

\* Listed above items are other manufacturer's products.



RS-422-2U-48

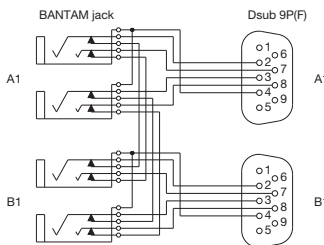

RS422 Patch Cord  
(See page 81)

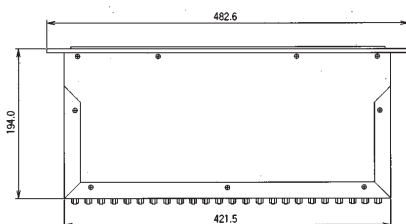

RS-422-1U-24

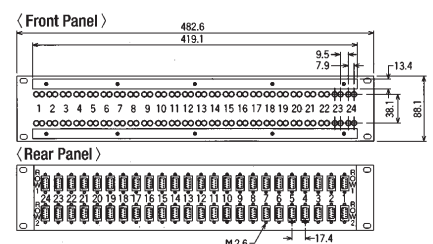
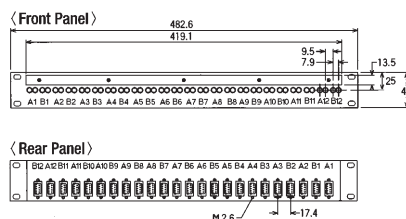

RS-422-2U-48

## Pre-Loaded A/V Connector Panels

### Key Features and Benefits

- Isolated BNC, RCA, F, XLR on same panel
- Clear plastic cover, full screen desi-strip
- Variety of panel options
- Most popular panel holes XLR F-77 and Neutrik D available

### XLR Connector Panels

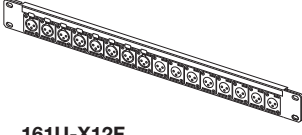
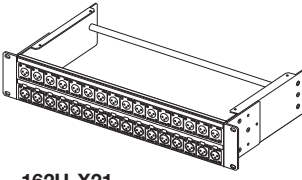
Type	Panel Size	Model	Loaded Connector	Panel P/N	Dimensions (mm)
 161U-X12F	1RU	161U-X1F	XLR3-31F77 (16pcs)	1U-AS1	44 x 482.6 x 39.7
		161U-X2F	XLR3-32F77 (16pcs)		44 x 482.6 x 26.6
		161U-X12F	XLR3-31F77 (8pcs, Left) XLR3-32F77 (8pcs, Right)		44 x 482.6 x 39.7
		161U-B1	NC3FD-LX-B (16pcs)	1U-AS1D	44 x 482.6 x 31.3
	161U-B2	NC3MD-LX-B (16pcs)	44 x 482.6 x 23.6		
 162U-X21	2RU	162U-X21	XJ3M-P3FA (16pcs, Upper Row) XJ3F-P3MA (16pcs, Lower Row)	2U-AS7	88.1 x 482.6 x 217
		162U-X22	XJ3M-P3FA (32pcs, 2rows)		

### BNC Connector Panels

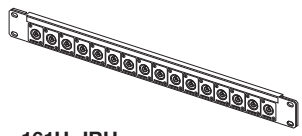
Type	Panel Size	Model	Loaded Connector	Panel P/N	Dimensions (mm)
 161U-JRU	1RU	161U-JRU	BCJ-JRU (16pcs)	1U-AS1	44 x 482.6 x 31.4
		161U-JRUDB	BCJ-JRUDB (16pcs)	1U-AS1D	44 x 482.6 x 29.1
	2RU	162U-JRU	BCJ-JRU (32pcs, 2rows)	2U-AS7	88.1 x 482.6 x 217

## XLR3 Panel Mount Adapters

Model	Description		Flange Type
	Front	Rear	
XJ3M-P3FA	XLR 3pin (M)	XLR 3pin (F)	ITT XLR-F77
XJ3M-P3MA	XLR 3pin (M)	XLR 3pin (M)	
XJ3F-P3FA	XLR 3pin (F)	XLR 3pin (F)	
XJ3F-P3MA	XLR 3pin (F)	XLR 3pin (M)	

- XJ3 series are XLR3 full compatible.
- XLR jack to jack extremely reduce installation hours.

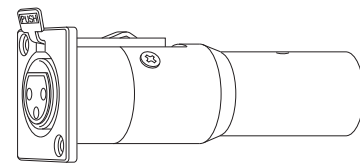

XJ3F-P3MA

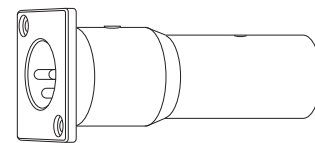

XJ3M-P3MA

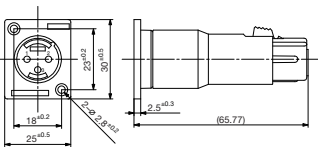

XJ3M-P3FA

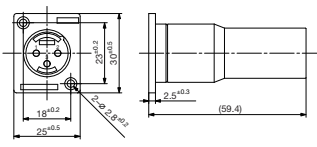

XJ3M-P3MA

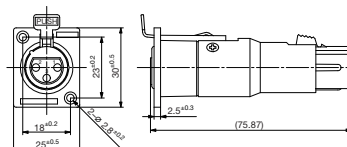

XJ3F-P3FA

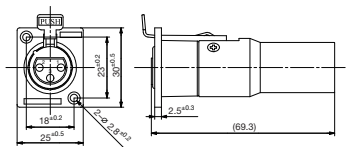

XJ3F-P3MA

## Blank Panels

Model	Description
BP-DXF (20pcs)	Snap-on blank panels for both ITT XLR-F77/Neutrik D holes
BP-XF (10pcs)	Blank panels for ITT XLR-F77 hole with screws
BP-D (10pcs)	Blank panels for Neutrik D hole with screws

### BP-DXF

- Easy and quick snap-on mounting without any tools
- Can be used for both ITT XLR-F77 and Neutrik D holes

Note: Panel thickness range: t1.2 to t2.3 mm



BP-DXF

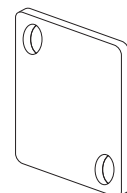

BP-XF

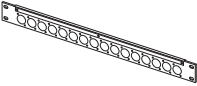
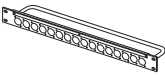
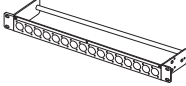
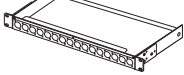
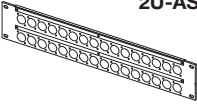
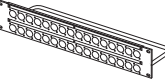
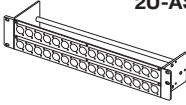
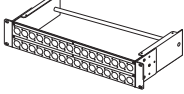
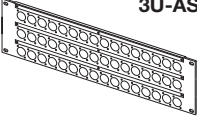
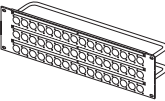
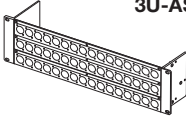
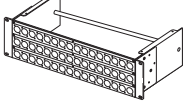

### Unloaded A/V Connector Panels

Panel Type	AS1 (D)	AS3 (D)	AS5 (D)	AS7 (D)
Description	Flat panel	Flat panel w/cable tie bar	Variable panel w/cable tie bar short type	Variable panel w/cable tie bar Long type
1RU 16 holes x 1 row	 <b>1U-AS1 (D)</b>	 <b>1U-AS3 (D)</b>	 <b>1U-AS5 (D)</b>	 <b>1U-AS7 (D)</b>
Depth (mm)	—	64.8	100	217
2RU 16 holes x 2 rows	 <b>2U-AS1 (D)</b>	 <b>2U-AS3 (D)</b>	 <b>2U-AS5 (D)</b>	 <b>2U-AS7 (D)</b>
Depth (mm)	—	64.8	100	217
3RU 16 holes x 3 rows	 <b>3U-AS1 (D)</b>	 <b>3U-AS3 (D)</b>	 <b>3U-AS5 (D)</b>	 <b>3U-AS7 (D)</b>
Depth (mm)	—	64.8	100	217

Variable panel can be recessed 25 mm.

### Ordering Information

#### Panel Height, Number of holes and Rows

<b>1U</b>	1RU, 16holes, 1row
<b>2U</b>	2RU, 32holes, 2rows
<b>3U</b>	3RU, 48holes, 3rows

**1U - AS3 D**

#### Hole Type

Blank	ITT XLR-F77 Type
<b>D</b>	Neutrik D Type

#### Panel Type

<b>AS1</b>	Flat panel
<b>AS3</b>	Flat panel w/cable tie bar
<b>AS5</b>	Variable panel w/ cable tie bar - short depth
<b>AS7</b>	Variable panel w/ cable tie bar - long depth

#### NOTE:

- Depending on their length, some connectors can not be mounted on the panel with a cable tie bar installed.

### Related Products

Model	Description
M-MA1U02	1RU mounting brackets for a Variable panel, 2 pcs. (left and right)
M-MA2U02	2RU mounting brackets for a Variable panel, 2 pcs. (left and right)
M-MA3U02	3RU mounting brackets for a Variable panel, 2 pcs. (left and right)
DS10-AS4	Designation strip for Canare A/V connector panels, 2 pcs.

### Examples of Custom-Made Connector Panels

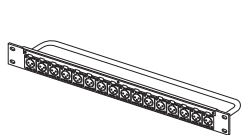

1U-AS3 + XLR3-31F77 × 16

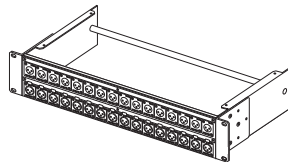

2U-AS7 + XLR3-32F77 × 16  
XLR3-31F77 × 16

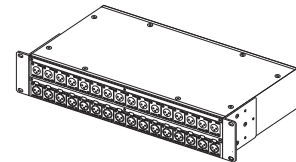

2U-AS7 (box type)  
Connectors can be mounted on the both side.

### Connectors

Canare Flush-mount BNC, F, RCA and XLR (ITT XLR-F77 or Neutrik D type) are available.

### Options

- A) Rear Panel A connector panel can be mounted on the rear.
- B) Box Type A connector panel, top plate and bottom plate can be mounted on the rear.
- C) Recessed Variable panel can be recessed 25mm by changing the screw positions of the mounting brackets and can be recessed either 50mm or 75mm by changing the mounting brackets to M-MA\*U02.

Options	AS1 (D)	AS3 (D)	AS5 (D)	AS7 (D)
A) Rear Panel	N/A	N/A	Available	Available
B) Box Type	N/A	N/A	N/A	Available
C) Recessed	N/A	N/A	Available	Available

# Audio Patchbays

## Audio Patchbays

The gold alloy cross bar contact, which features a low faulty contact rate, is used for the jacks.

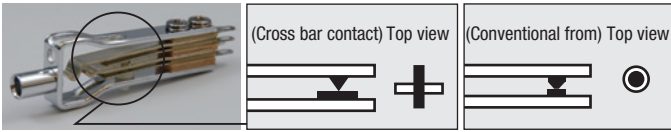

- 481U patchbay can be recessed 25mm by changing the screw positions on the mounting brackets.

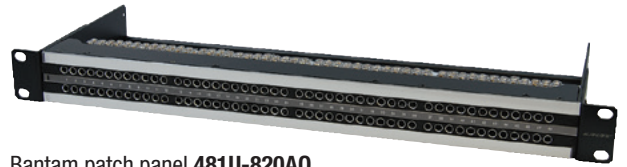

Bantam patch panel 481U-820AQ



Bantam patch panel 48-12A/820AQ/EIA

Model	Description	Connector
481U-820AQ	Bantam Patchbay	820AQ×96

Model	Description	Connector
48-12A/820AQ/EIA	Bantam Patchbay	820AQ×96
32-12A/620A/EIA	Skini Patchbay	620A×64
612A/320A/EIA	Maxi Patchbay	320A×52

\* Listed above items are other manufacturer's products.

## Audio Patchbays Related Products

Model	Description
320A	Maxi Jack
620A	Skini Jack
820AQ	Bantam Jack
ABJ-DC	Bantam Jack Dust Cap (100pcs/pkg)
NP3TMC-B	Maxi/Skini Plug
PJ743	Bantam Termination Plug (600Ω)
PJ748	Bantam Dummy Plug
6000AQ	Polysand for PJ743
PH50-A	Maxi/Skini/Video Patch Cord Holder
PH50-B	Bantam Patch Cord Holder
DS10-AS1	Designation Strip for Bantam (2pcs.)
DS10-AS2	Designation Strip for Skini (2pcs.)
DS10-AS3	Designation Strip for Maxi (2pcs.)

\* Listed above items are other manufacturer's products.

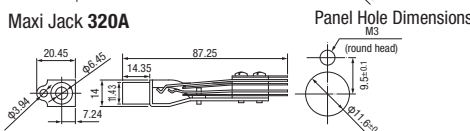
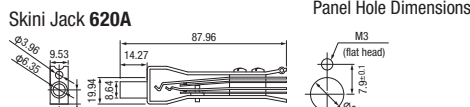
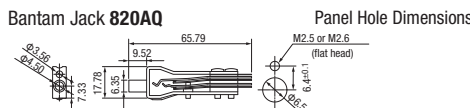
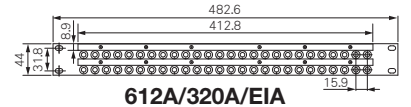
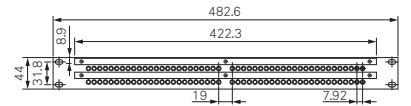
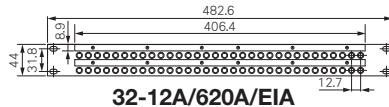
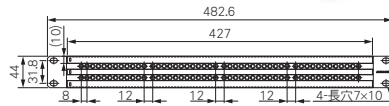

BC \* M  
(See page 84 for patch cords.)



### Patch Cord Holder

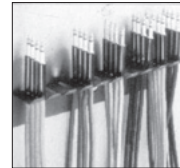

Capable up to 50 patch cords.  
Easy to install on the wall or side of rack.  
**PH50-A**  
for Maxi/Skini, Video cords.  
**PH50-B**  
for Bantam cords.

### Polysand 6000AQ (for PJ743)



Quickly and effectively removes oxide on brass plugs.  
Comes in 286x150mm size.

## Technical Note

### Audio Patchbay Normalizing Descriptions

Output from a device is obtained from the upper row, while input to a device is normally connected to the lower row. Users can select from the following three types of connecting functions.

<Wiring formats connecting upper and lower connectors>

F: Full normal connection

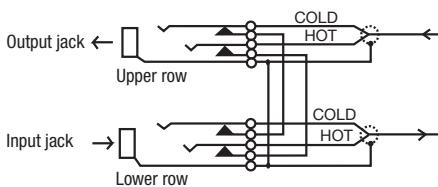

#### Full Normal Format (series)

The upper (output) row is connected to the lower row (input) in the state when a plug is not inserted.  
When a plug is inserted in the upper jack to obtain a signal, the signal is not connected to the lower jack. A signal can be entered by inserting a plug in the lower jack. In this case the signal is not connected to the upper jack.

H: Half normal connection

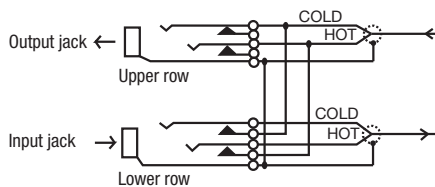

#### Half Normal Format (half-parallel)

The upper (output) row is connected to the lower row (input) in the state when a plug is not inserted.  
When a plug is inserted in the upper jack to obtain a signal, the signal is connected to the lower jack. This format allows the signal to be obtained in parallel. The signal can be prevented from going to the lower jack by inserting a dummy plug.  
Signals are input by inserting a plug in the lower jack. In this case the signal is not connected to the upper jack.

W: Double normal connection

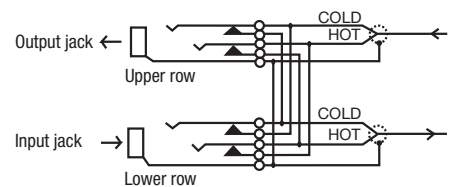

#### Double Normal Format (series-parallel)

The upper (output) row is connected to the lower row (input) in the state when a plug is not inserted.  
When a plug is inserted in the upper jack to obtain a signal, the signal is connected to the lower jack. This format allows the signal to be obtained in parallel. The signal can be prevented from going to the lower jack by inserting a dummy plug.  
A signal can be entered by inserting another plug in the lower jack. Note that the signal in this case is connected to the upper jack.  
This can be prevented by inserting a dummy plug.

### Wired Box

Type	Model	Size	Connector	
			Front	Rear
Bantam	481U-WBF	1RU	820AQ × 96	90-602 × 4
	481U-WBH	1RU	820AQ × 96	90-602 × 4
	481U-WBW	1RU	820AQ × 96	90-602 × 4
	481U-WBS	1RU	820AQ × 96	90-602 × 4
	48WB-F	1RU	820AQ × 96	90-602 × 4
	48WB-H	1RU	820AQ × 96	90-602 × 4
Skini	32WB-F	1RU	620A × 64	90-602 × 4
	32WB-H	1RU	620A × 64	90-602 × 4
	32WB-W	1RU	620A × 64	90-602 × 4
Maxi	26WB-F	1RU	320A × 52	90-602 × 4
	26WB-H	1RU	320A × 52	90-602 × 4
	26WB-W	1RU	320A × 52	90-602 × 4

\*481U-WB\* can be recessed 25mm  
 \*90-602 connector is identical to  
 ELCO 00-8016-090-\*\*\*-702V connector



90-602

### Wired Panels

Type	Model	Panel 1		Panel 2	
		Size	Connector	Size	Connector
Bantam	48XP-F	1RU	820AQ × 96	3RU × 2	XLR3-31F77 × 48 XLR3-32F77 × 48
	48XP-H	1RU	820AQ × 96	3RU × 2	XLR3-31F77 × 48 XLR3-32F77 × 48
	48XP-W	1RU	820AQ × 96	3RU × 2	XLR3-31F77 × 48 XLR3-32F77 × 48
Skini	32XP-F	1RU	620A × 64	4RU	XLR3-31F77 × 32 XLR3-32F77 × 32
	32XP-H	1RU	620A × 64	4RU	XLR3-31F77 × 32 XLR3-32F77 × 32
	32XP-W	1RU	620A × 64	4RU	XLR3-31F77 × 32 XLR3-32F77 × 32

\*Cables are 2 meters in length.

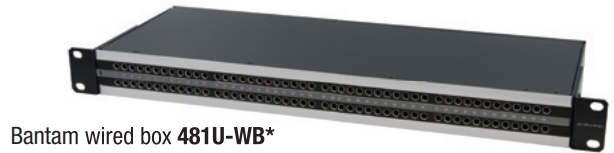

Bantam wired box 481U-WB\*

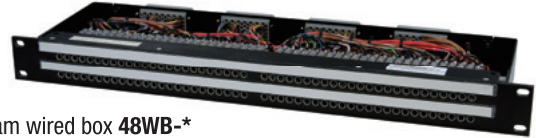

Bantam wired box 48WB-\*

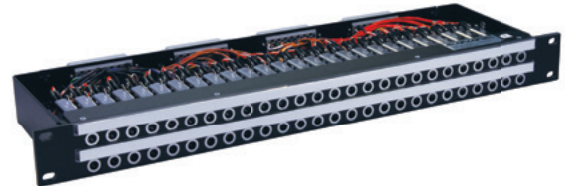

Maxi wired box 26WB-\*

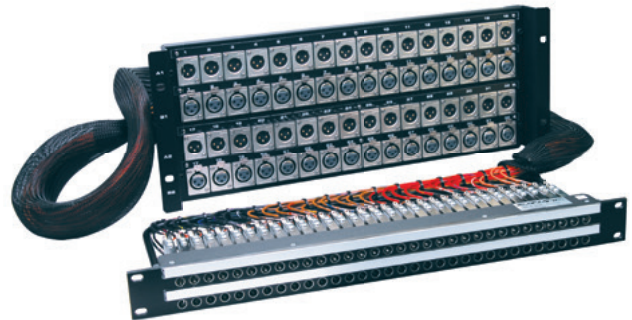

Skini wired panel 32XP-\*

Normaling Options	
481U-WB*	F: Full normal
48WB-*	H: Half normal
48XP-*	W: Double normal
	S: Single (No normal)



TC\*\*B

(See page 84 for patch cords)

### 90-602 Connector Format (Wired box) <Rear panel>



Bantam	Lower row 25~48ch	Upper row 25~48ch	Lower row 1~24ch	Upper row 1~24ch
Skini	Lower row 17~32ch	Upper row 17~32ch	Lower row 1~16ch	Upper row 1~16ch
Maxi	Lower row 14~26ch	Upper row 14~26ch	Lower row 1~13ch	Upper row 1~13ch

90-602 connector is mated with 90-608 connector.  
 90-608 requires either 125 or 525 contact and 90-T cover for assembling.

<Wired box side>

90-602

(00-8016-090-000-702V)

<Cable side>

90-608 (00-8016-090-000-708V)

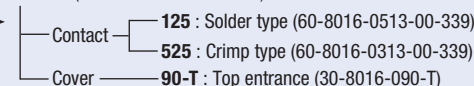

\*The numbers in parentheses are ELCO ordering codes.

\*\* Contact extraction tool: 06-1877-04.

Crimping pliers for 525: 06-1001-015 (AWG#18), 06-1001-016 (AWG#20-#22), 06-1001-017 (AWG#24-#26).

### Wiring Table for 90-602

Channel no.	Maxi		Skini		Bantam		HOT	COLD	SHIELD
	1	14	1	17	1	25	A	H	R
2	15	2	18	2	26	B	J	S	
3	16	3	19	3	27	C	K	T	
4	17	4	20	4	28	D	L	U	
5	18	5	21	5	29	E	M	V	
6	19	6	22	6	30	F	N	W	
7	20	7	23	7	31	X	AE	AM	
8	21	8	24	8	32	Y	AF	AN	
9	22	9	25	9	33	Z	AH	AP	
10	23	10	26	10	34	AA	AJ	AR	
11	24	11	27	11	35	AB	AK	AS	
12	25	12	28	12	36	AC	AL	AT	
13	26	13	29	13	37	BJ	BS	BY	
		14	30	14	38	BK	BT	BZ	
		15	31	15	39	BL	BU	CA	
		16	32	16	40	BM	BV	CB	
				17	41	BN	BW	CC	
				18	42	BP	BX	CD	
				19	43	CF	CN	CW	
				20	44	CH	CP	CX	
				21	45	CJ	CR	CY	
				22	46	CK	CS	CZ	
				23	47	CL	CT	DA	
				24	48	CM	CU	DB	



■ Snake Trunk

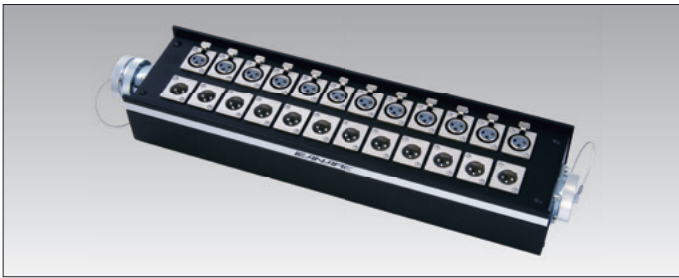

■ Junction Box



■ Fantail



■ Cable Reel Snake

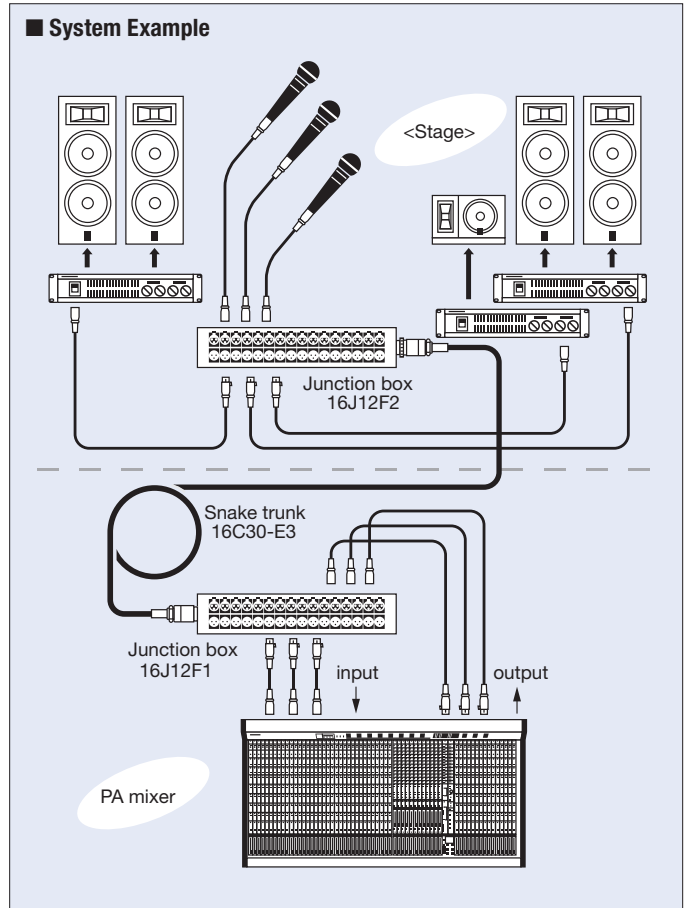

**Connectors used with Canare multichannel cable system**

Cable mount	Panel mount	Cable mount	Panel mount
XLR3-11C (female)	XLR3-32F77 (male)	XLR3-12C (male)	XLR3-31F77 (female)
For multichannel cable	For Junction box	For multichannel cable	For Junction box
Plug	Receptacle	Plug	Receptacle
NK27-21C-R (female) + NK-AD1-R (barrel extension)	NK27-32S-R (male)	FK37-21C-R (female) + FK-AD2-R (barrel extension)	FK37-32S-R (male)
NK27-22C-R (male) + NK-AD1-R (barrel extension)	NK27-31S-R (female)	FK37-22C-R (male) + FK-AD2-R (barrel extension)	FK37-31S-R (female)
D/MS3106B32A-10S (female) + EB-02 (barrel extension) + D/MS3057-20A (cable clamp)	D/MS3102A32A-10P (male)	D/MS3106B36-73S (female) + EB-03 (barrel extension) + D/MS3057-24A (cable clamp)	D/MS3102A36-73P (male)
8 • 12 ch		16 ch	
24 ch		32 ch	

Fiber-Optic Systems

Connectors



Cables

Panels & Patchbays

Multichannel Systems





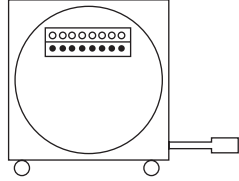
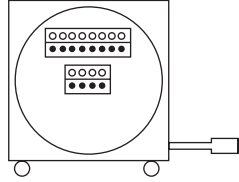
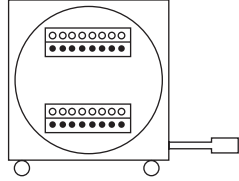
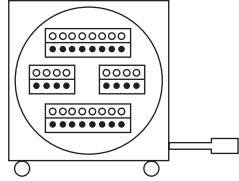

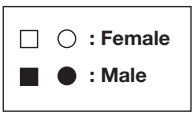

Cable Assemblies

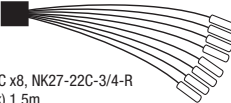
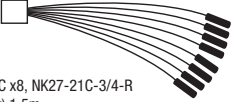
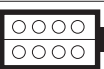

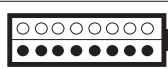
	Snake Trunks	Cable Reel Snakes																																										
8 CH	<p><b>L-4E3</b> Star quad, Braided shield</p>  <p>connector : NK27-21C 3/4-R, NK27-22C 3/4-R cable : L-4E3-8P (black) rubber bushing : AN3420-12 + Heat Shrink Tube</p> <table border="1"> <thead> <tr> <th>Model</th> <th>Length</th> <th>Weight</th> </tr> </thead> <tbody> <tr> <td>8C05-E3</td> <td>5m</td> <td>1.6kg</td> </tr> <tr> <td>8C10-E3</td> <td>10m</td> <td>3.0kg</td> </tr> <tr> <td>8C30-E3</td> <td>30m</td> <td>8.4kg</td> </tr> <tr> <td>8C50-E3</td> <td>50m</td> <td>13.8kg</td> </tr> </tbody> </table>	Model	Length	Weight	8C05-E3	5m	1.6kg	8C10-E3	10m	3.0kg	8C30-E3	30m	8.4kg	8C50-E3	50m	13.8kg	<p><b>M2</b> Two-cord, AT shield</p>  <p>connector : NK27-21C 3/4-R, NK27-22C 3/4-R cable : M202-8AT (black) rubber bushing : AN3420-10, 12 + Heat Shrink Tube</p> <table border="1"> <thead> <tr> <th>Model</th> <th>Length</th> <th>Weight</th> </tr> </thead> <tbody> <tr> <td>8C10-M2</td> <td>10m</td> <td>1.7kg</td> </tr> <tr> <td>8C30-M2</td> <td>30m</td> <td>4.5kg</td> </tr> <tr> <td>8C50-M2</td> <td>50m</td> <td>7.3kg</td> </tr> </tbody> </table>	Model	Length	Weight	8C10-M2	10m	1.7kg	8C30-M2	30m	4.5kg	8C50-M2	50m	7.3kg	 <p>connector : NK27-21C-3/4-R cable : L-4E3-8P (black)</p> <table border="1"> <thead> <tr> <th>Model</th> <th>Length</th> <th>Weight</th> <th>Cable reel</th> </tr> </thead> <tbody> <tr> <td>8R30-E3</td> <td>30m</td> <td>18.1kg</td> <td>R380</td> </tr> <tr> <td>8R50-E3</td> <td>50m</td> <td>23.0kg</td> <td>R380</td> </tr> </tbody> </table>	Model	Length	Weight	Cable reel	8R30-E3	30m	18.1kg	R380	8R50-E3	50m	23.0kg	R380		
	Model	Length	Weight																																									
8C05-E3	5m	1.6kg																																										
8C10-E3	10m	3.0kg																																										
8C30-E3	30m	8.4kg																																										
8C50-E3	50m	13.8kg																																										
Model	Length	Weight																																										
8C10-M2	10m	1.7kg																																										
8C30-M2	30m	4.5kg																																										
8C50-M2	50m	7.3kg																																										
Model	Length	Weight	Cable reel																																									
8R30-E3	30m	18.1kg	R380																																									
8R50-E3	50m	23.0kg	R380																																									
12 CH	<p>connector : NK27-21C 7/8-R, NK27-22C 7/8-R cable : L-4E3-12P (black) rubber bushing : AN3420-16</p> <table border="1"> <thead> <tr> <th>Model</th> <th>Length</th> <th>Weight</th> </tr> </thead> <tbody> <tr> <td>12C05-E3</td> <td>5m</td> <td>2.1kg</td> </tr> <tr> <td>12C10-E3</td> <td>10m</td> <td>3.9kg</td> </tr> <tr> <td>12C30-E3</td> <td>30m</td> <td>11.1kg</td> </tr> <tr> <td>12C50-E3</td> <td>50m</td> <td>18.3kg</td> </tr> </tbody> </table>	Model	Length	Weight	12C05-E3	5m	2.1kg	12C10-E3	10m	3.9kg	12C30-E3	30m	11.1kg	12C50-E3	50m	18.3kg	<p>connector : NK27-21C 3/4-R, NK27-22C 3/4-R cable : M202-12AT (black) rubber bushing : AN3420-10, 12 + Heat Shrink Tube</p> <table border="1"> <thead> <tr> <th>Model</th> <th>Length</th> <th>Weight</th> </tr> </thead> <tbody> <tr> <td>12C10-M2</td> <td>10m</td> <td>2.1kg</td> </tr> <tr> <td>12C30-M2</td> <td>30m</td> <td>5.8kg</td> </tr> <tr> <td>12C50-M2</td> <td>50m</td> <td>9.3kg</td> </tr> </tbody> </table>	Model	Length	Weight	12C10-M2	10m	2.1kg	12C30-M2	30m	5.8kg	12C50-M2	50m	9.3kg	 <p>connector : NK27-21C-7/8-R cable : L-4E3-12P (black)</p> <table border="1"> <thead> <tr> <th>Model</th> <th>Length</th> <th>Weight</th> <th>Cable reel</th> </tr> </thead> <tbody> <tr> <td>12R30-E3</td> <td>30m</td> <td>20.6kg</td> <td>R380</td> </tr> <tr> <td>12R50-E3</td> <td>50m</td> <td>30.4kg</td> <td>R460</td> </tr> </tbody> </table>	Model	Length	Weight	Cable reel	12R30-E3	30m	20.6kg	R380	12R50-E3	50m	30.4kg	R460		
	Model	Length	Weight																																									
12C05-E3	5m	2.1kg																																										
12C10-E3	10m	3.9kg																																										
12C30-E3	30m	11.1kg																																										
12C50-E3	50m	18.3kg																																										
Model	Length	Weight																																										
12C10-M2	10m	2.1kg																																										
12C30-M2	30m	5.8kg																																										
12C50-M2	50m	9.3kg																																										
Model	Length	Weight	Cable reel																																									
12R30-E3	30m	20.6kg	R380																																									
12R50-E3	50m	30.4kg	R460																																									
16 CH	<p>connector : FK37-21C 7/8-R, FK37-22C 7/8-R cable : L-4E3-16P (black) rubber bushing : AN3420-16</p> <table border="1"> <thead> <tr> <th>Model</th> <th>Length</th> <th>Weight</th> </tr> </thead> <tbody> <tr> <td>16C05-E3</td> <td>5m</td> <td>2.6kg</td> </tr> <tr> <td>16C10-E3</td> <td>10m</td> <td>4.9kg</td> </tr> <tr> <td>16C30-E3</td> <td>30m</td> <td>14.1kg</td> </tr> <tr> <td>16C50-E3</td> <td>50m</td> <td>23.3kg</td> </tr> </tbody> </table>	Model	Length	Weight	16C05-E3	5m	2.6kg	16C10-E3	10m	4.9kg	16C30-E3	30m	14.1kg	16C50-E3	50m	23.3kg	<p>connector : FK37-21C 7/8-R, FK37-22C 7/8-R cable : M202-16AT (black) rubber bushing : AN3420-10, 12, 16</p> <table border="1"> <thead> <tr> <th>Model</th> <th>Length</th> <th>Weight</th> </tr> </thead> <tbody> <tr> <td>16C10-M2</td> <td>10m</td> <td>2.7kg</td> </tr> <tr> <td>16C30-M2</td> <td>30m</td> <td>7.5kg</td> </tr> <tr> <td>16C50-M2</td> <td>50m</td> <td>12.3kg</td> </tr> </tbody> </table>	Model	Length	Weight	16C10-M2	10m	2.7kg	16C30-M2	30m	7.5kg	16C50-M2	50m	12.3kg	 <p>connector : FK37-21C-7/8-R cable : L-4E3-16P (black)</p> <table border="1"> <thead> <tr> <th>Model</th> <th>Length</th> <th>Weight</th> <th>Cable reel</th> </tr> </thead> <tbody> <tr> <td>16R30-E3</td> <td>30m</td> <td>24.1kg</td> <td>R380</td> </tr> <tr> <td>16R50-E3</td> <td>50m</td> <td>36.1kg</td> <td>R460</td> </tr> </tbody> </table>	Model	Length	Weight	Cable reel	16R30-E3	30m	24.1kg	R380	16R50-E3	50m	36.1kg	R460		
	Model	Length	Weight																																									
16C05-E3	5m	2.6kg																																										
16C10-E3	10m	4.9kg																																										
16C30-E3	30m	14.1kg																																										
16C50-E3	50m	23.3kg																																										
Model	Length	Weight																																										
16C10-M2	10m	2.7kg																																										
16C30-M2	30m	7.5kg																																										
16C50-M2	50m	12.3kg																																										
Model	Length	Weight	Cable reel																																									
16R30-E3	30m	24.1kg	R380																																									
16R50-E3	50m	36.1kg	R460																																									
24 CH	<p>connector : ◊MS3106B-32A10S+D/MS3057-20A×2 cable : L-4E3-24P (black) rubber bushing : AN3420-20</p> <table border="1"> <thead> <tr> <th>Model</th> <th>Length</th> <th>Weight</th> </tr> </thead> <tbody> <tr> <td>24C05-E3</td> <td>5m</td> <td>4.3kg</td> </tr> <tr> <td>24C10-E3</td> <td>10m</td> <td>7.7kg</td> </tr> <tr> <td>24C30-E3</td> <td>30m</td> <td>21.7kg</td> </tr> <tr> <td>24C50-E3</td> <td>50m</td> <td>35.7kg</td> </tr> </tbody> </table> <p>Extension Cord ◊MS3101A32A10P-D/MS3057-20A×2 Cable:L-4E3-24P (black)</p> <table border="1"> <thead> <tr> <th>Model</th> <th>Length</th> <th>Weight</th> </tr> </thead> <tbody> <tr> <td>24C005-E3MS22</td> <td></td> <td></td> </tr> </tbody> </table>	Model	Length	Weight	24C05-E3	5m	4.3kg	24C10-E3	10m	7.7kg	24C30-E3	30m	21.7kg	24C50-E3	50m	35.7kg	Model	Length	Weight	24C005-E3MS22			<p>connector : ◊MS3106B-32A10S+D/MS3057-20A×2 cable : M202-24AT (black) rubber bushing : AN3420-16, 20 + Heat Shrink Tube</p> <table border="1"> <thead> <tr> <th>Model</th> <th>Length</th> <th>Weight</th> </tr> </thead> <tbody> <tr> <td>24C10-M2</td> <td>10m</td> <td>4.0kg</td> </tr> <tr> <td>24C30-M2</td> <td>30m</td> <td>10.4kg</td> </tr> <tr> <td>24C50-M2</td> <td>50m</td> <td>16.8kg</td> </tr> </tbody> </table>	Model	Length	Weight	24C10-M2	10m	4.0kg	24C30-M2	30m	10.4kg	24C50-M2	50m	16.8kg	 <p>connector : D/MS3106B-32A10S cable : L-4E3-24P (black)</p> <table border="1"> <thead> <tr> <th>Model</th> <th>Length</th> <th>Weight</th> <th>Cable reel</th> </tr> </thead> <tbody> <tr> <td>24R30-E3</td> <td>30m</td> <td>34.6kg</td> <td>R460</td> </tr> </tbody> </table>	Model	Length	Weight	Cable reel	24R30-E3	30m	34.6kg	R460
	Model	Length	Weight																																									
24C05-E3	5m	4.3kg																																										
24C10-E3	10m	7.7kg																																										
24C30-E3	30m	21.7kg																																										
24C50-E3	50m	35.7kg																																										
Model	Length	Weight																																										
24C005-E3MS22																																												
Model	Length	Weight																																										
24C10-M2	10m	4.0kg																																										
24C30-M2	30m	10.4kg																																										
24C50-M2	50m	16.8kg																																										
Model	Length	Weight	Cable reel																																									
24R30-E3	30m	34.6kg	R460																																									
32 CH	<p>connector : ◊MS3106B36-73S+D/MS3057-24A×2 cable : M202-32AT (black) rubber bushing : AN3420-16, 20, 24</p> <table border="1"> <thead> <tr> <th>Model</th> <th>Length</th> <th>Weight</th> </tr> </thead> <tbody> <tr> <td>32C10-M2</td> <td>10m</td> <td>4.8kg</td> </tr> <tr> <td>32C30-M2</td> <td>30m</td> <td>13.1kg</td> </tr> <tr> <td>32C50-M2</td> <td>50m</td> <td>21.0kg</td> </tr> </tbody> </table> <p>Extension Cord</p> <p>connector : ◊MS3101A36-73P+D/MS3057-24A×2 cable : M202-32AT (black)</p> <table border="1"> <thead> <tr> <th>Model</th> <th>Length</th> <th>Weight</th> </tr> </thead> <tbody> <tr> <td>32C005-M2MS22</td> <td></td> <td></td> </tr> </tbody> </table>	Model	Length	Weight	32C10-M2	10m	4.8kg	32C30-M2	30m	13.1kg	32C50-M2	50m	21.0kg	Model	Length	Weight	32C005-M2MS22																											
Model	Length	Weight																																										
32C10-M2	10m	4.8kg																																										
32C30-M2	30m	13.1kg																																										
32C50-M2	50m	21.0kg																																										
Model	Length	Weight																																										
32C005-M2MS22																																												

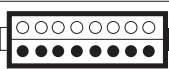
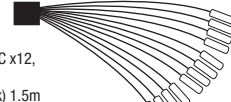

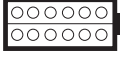
Note: Connecting cables 24C005-E3MS22 and 32C005-M2MS22 are to be used to interconnect snake trunks only and they do not mate with our other standard snake system.

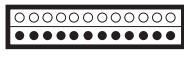
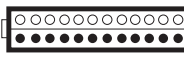
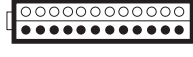
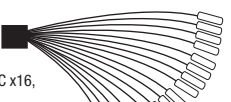
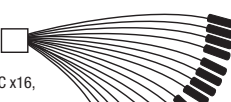
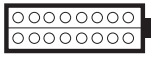
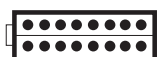
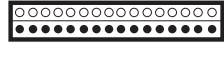
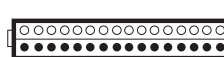
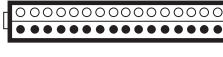
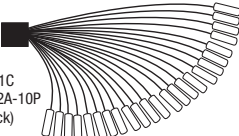
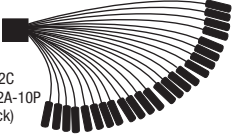
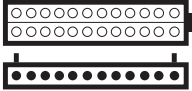
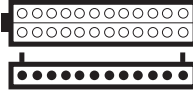
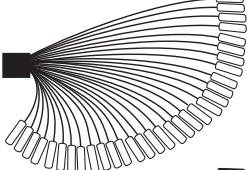
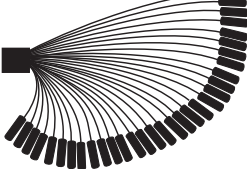
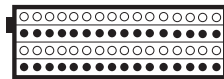
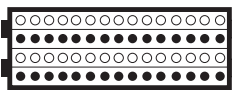
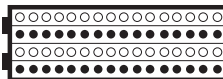
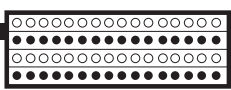
Fantails	Junction Boxes		
<p><b>8S1N2</b> Connector : XLR3-11C x8, NK27-22C-3/4-R Cable : L-4E6S (black) 1.5m Weight : 1.1kg</p>  <p><b>8S2N1</b> Connector : XLR3-12C x8, NK27-21C-3/4-R Cable : L-4E6S (black) 1.5m Weight : 1.0kg</p> 	<p>Single XLR per channel</p>  <p><b>8B1N2</b> Connector: XLR3-31F77 x8, NK27-32S-R x1 Weight : 0.9kg</p>  <p><b>8B2N1</b> Connector: XLR3-32F77 x8, NK27-31S-R x1 Weight : 1.1kg</p>	<p>Parallel XLR per channel</p>  <p><b>8J12N2</b> Connector: XLR3-31F77 x8, XLR3-32F77 x8 NK27-32S-R x1 Weight : 1.5kg</p>  <p><b>8J12N1</b> Connector: XLR3-31F77 x8, XLR3-32F77 x8 NK27-31S-R x1 Weight : 1.5kg</p>	<p>Parallel XLR per channel MultiPin feed through</p>  <p><b>8J12N12</b> Connector: XLR3-31F77 x8, XLR3-32F77 x8 NK27-31S-R x1, NK27-32S-R x1 Weight : 1.6kg</p>
<p><b>12S1N2</b> Connector : XLR3-11C x12, NK27-22C-3/4-R Cable : L-4E5C (black) 1.5m Weight : 1.4kg</p>  <p><b>12S2N1</b> Connector : XLR3-12C x12, NK27-21C-3/4-R Cable : L-4E5C (black) 1.5m Weight : 1.3kg</p> 	<p><b>12B1N2</b> Connector: XLR3-31F77 x12, NK27-32S-R x1 Weight : 1.3kg</p>  <p><b>12B2N1</b> Connector: XLR3-32F77 x12, NK27-31S-R x1 Weight : 1.2kg</p> 	<p><b>12J12N2</b> Connector: XLR3-31F77 x12, XLR3-32F77 x12 NK27-32S-R x1 Weight : 2.1kg</p>  <p><b>12J12N1</b> Connector: XLR3-31F77 x12, XLR3-32F77 x12 NK27-31S-R x1 Weight : 2.1kg</p> 	<p><b>12J12N12</b> Connector: XLR3-31F77 x12, XLR3-32F77 x12 NK27-31S-R x1, NK27-32S-R x1 Weight : 2.2kg</p> 
<p><b>16S1F2</b> Connector : XLR3-11C x16, FK37-22C-7/8-R Cable : L-4E5C (black) 1.5m Weight : 1.9kg</p>  <p><b>16S2F1</b> Connector : XLR3-12C x16, FK37-22C-7/8-R Cable : L-4E5C (black) 1.5m Weight : 1.7kg</p> 	<p><b>16B1F2</b> Connector: XLR3-31F77 x16, FK37-32S-R x1 Weight : 1.6kg</p>  <p><b>16B2F1</b> Connector: XLR3-32F77 x16, FK37-31S-R x1 Weight : 1.3kg</p> 	<p><b>16J12F2</b> Connector: XLR3-31F77 x16, XLR3-32F77 x16 FK37-32S-R x1 Weight : 2.5kg</p>  <p><b>16J12F1</b> Connector: XLR3-31F77 x16, XLR3-32F77 x16 FK37-31S-R x1 Weight : 2.5kg</p> 	<p><b>16J12F12</b> Connector: XLR3-31F77 x16, XLR3-32F77 x16 FK37-31S-R x1, FK37-32S-R x1 Weight : 2.6kg</p> 
<p><b>24S1MS2</b> Connector : XLR3-11C x24, D/MS3101A-32A-10P Cable : L-4E5C (black) 2m</p>  <p><b>24S2MS2</b> Connector : XLR3-12C x24, D/MS3101A-32A-10P Cable : L-4E5C (black) 2m</p> 		<p><b>24B12MS</b> Connector: XLR3-31F77 x24 (on top) XLR3-32F77 x24 (12 on each side) D/MS3102A-32A10P Weight : 2.7kg</p> 	<p><b>24B12MSW</b> Connector: XLR3-31F77 x24 (on top) XLR3-32F77 x24 (12 on each side) D/MS3102A-32A10P x2 Weight : 3.0kg</p> 
<p><b>32S1MS2</b> Connector : XLR3-11C x32, D/MS3101A-36-73P Cable : L-4E5C (black) 2m</p>  <p><b>32S2MS2</b> Connector : XLR3-12C x32, D/MS3101A-36-73P Cable : L-4E5C (black) 2m</p> 		<p><b>32B12MS</b> Connector: XLR3-31F77 x32, XLR3-32F77 x32 D/MS3102A36-73P Weight : 5.3kg</p>  <p><b>32B12MWF11</b> Connector: XLR3-31F77 x32, XLR3-32F77 x32 D/MS3102A36-73P x2, FK37-31S-R x2 Weight : 6.0kg</p> 	<p><b>32B12MSW</b> Connector: XLR3-31F77 x32, XLR3-32F77 x32 D/MS3102A36-73P x2 Weight : 5.5kg</p>  <p><b>32B12MF11</b> Connector: XLR3-31F77 x32, XLR3-32F77 x32 D/MS3102A36-73P x1, FK37-31S-R x2 Weight : 5.7kg</p> 

Fiber-Optic Systems

Connectors

Cables

Panels & Patchbays

Multichannel Systems

Cable Assemblies

### Multichannel Connector Pin Assignments

Ch No.	Cable Unit Identification		32ch		24ch		16ch		8ch / 12ch		
	L-4E3	M202	D/MS3102A36-73 D/MS3106B36-73		D/MS3102A32A-10 D/MS3106B32A-10		FK37		NK27		
	Spiral Marker Color	Insulator Color	HOT	COLD	HOT	COLD	HOT	COLD	HOT	COLD	
1	RED	RED • WHT	A	B	A	B	1	2	1	3	
2	BLU	BLU •	C	D	C	D	3	4	4	5	
3	YEL	YEL •	F	H	F	G	5	6	6	7	
4	GRN	GRN •	J	K	H	J	8	9	8	9	
5	BRN	BRN •	L	M	K	L	10	11	11	12	
6	N/A	GRY • ▼	N	P	N	O	12	13	13	14	
7	BLU • BLK	BLU • BLK	R	S	P	R	14	15	15	16	
8	YEL • BLK	YEL •	T	U	S	T	16	17	17	18	
9	GRN • BLK	GRN •	V	W	U	V	21	22	19	20	
10	BRN • BLK	BRN •	Y	Z	X	Y	23	24	22	23	
11	BLK	GRY • ▼	a	b	Z	a	25	26	24	25	
12	BLU • ORN	BLU • ORN	c	d	b	c	27	28	26	27	
13	YEL • ORN	YEL •	f	g	d	e	29	30	SHIELD		
14	GRN • ORN	GRN •	h	i	g	h	32	33	10		
15	BRN • ORN	BRN •	j	k	j	k	34	35			
16	ORN	GRY • ▼	m	n	m	n	36	37			
17	BLU • PNK	BLU • PNK	u	v	p	q	SHIELD				
18	YEL • PNK	YEL •	w	x	s	t	19				
19	GRN • PNK	GRN •	y	z	u	v					
20	BRN • PNK	BRN •	AA	AB	w	x					
21	PNK	GRY • ▼	AC	AD	AB	z					
22	BLU • WHT	BLU • RED	AE	AF	AA	AC					
23	YEL • WHT	YEL •	AH	AJ	AD	AF					
24	GRN • WHT	GRN •	AL	AM	AG	AE					
25	—	BRN •	AN	AP	SHIELD						
26	—	GRY • ▼	AR	AS	E						
27	—	YEL • BLU	AT	AU							
28	—	GRN •	AV	AW							
29	—	BRN • ▼	AX	AY							
30	—	GRN • YEL	AZ	BA							
31	—	BRN •	BC	BD							
32	—	GRY • ▼	BE	BF							
			SHIELD								
			E	q	t						
			X	r	AK						
			p	s	BB						

32ch

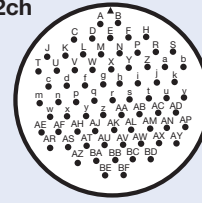

24ch

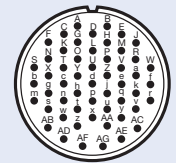

16ch

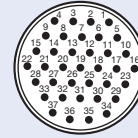

8-12ch

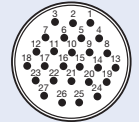

#### ■ Connection Method

##### L-4E3 Types:

Identify the channel number by the color of the spiral marker on the inner jacket (gray). The unit is 4-core construction and the insulator colors are blue, blue, white, and white. Connect these with the same colored cores, so that the blue cores are connected to Hot and the white cores to Cold.

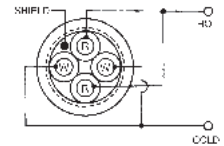

##### M202 Types:

The unit is 2-core construction, with the channel number identified by the insulator color (a combination of the identifying color and common identifying color). Connect the identifying color core to Hot, and the common identifying color core to Cold.

#### ■ Connections to XLR Connectors

Polarity	HOT	COLD	SHIELD
Pin No.	2	3	1

## Cable Reels

### Plain reels for winding cable

Model	Weight (kg)	Description	Stackability
R460-S	9.9	Reel unit for cable winding / With caster.	N/A
R380-S	8.3	Reel unit for cable winding / With caster.	N/A
R300-S	4.3	Reel unit for cable winding.	✓
R300	4.3	Front panel can be refurbished to create connector mounting holes.	✓
R300-L	4.3	Both front panel and drum can be refurbished to create connector mounting holes.	✓
R300-CN	4.3	Both panel and drum have 2 XLR connectors (one male, one female) installed.	✓
R300-BN	4.3	Both panel and drum have BNC receptacles (one each).	✓

- 3-speed brake controller. (Lock/Soft/Free)
- Non-lubricated bearings.
- Rugged E frame design.

### Wiring

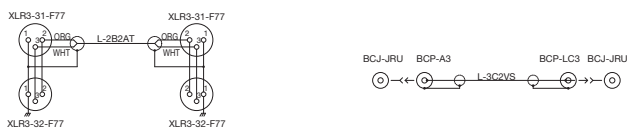

R300-CN

R300-BN

## Reel with Cable Assembly

### Cable detachable type.

Model	Cable reel	Description			Weight (kg)
		Inner end	Cable	Outer end	
CR100-CN	R300-CN	XLR3-12C	L-4E6S(100m)	XLR3-11C	9.6
CR100-S	R300-S	XLR3-12C	L-4E6S(100m)	XLR3-11C	9.6
CR90-BN	R300-BN	BCP-H5B	L-5C2VS(90m)	BCP-H5B	10.5

### Dimensions

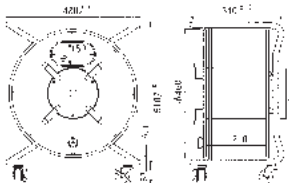

R460-S

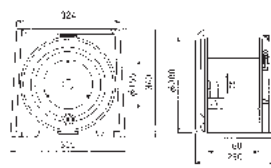

R300

(Connectors can be attached to the front panel)

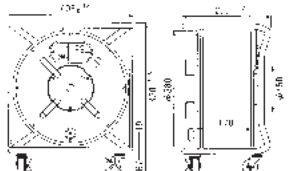

R380-S

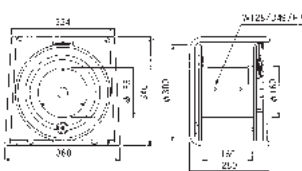

R300-L

(Connectors can be attached to the front panel and the drum)

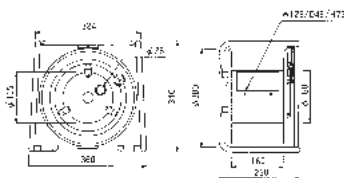

R300-S

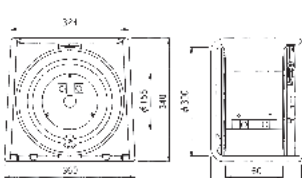

R300-CN

(R300-BN comes with BNC receptacles)



3-speed brake controller



R460-S



R300-S



CR100-CN

### Cable winding length reference chart

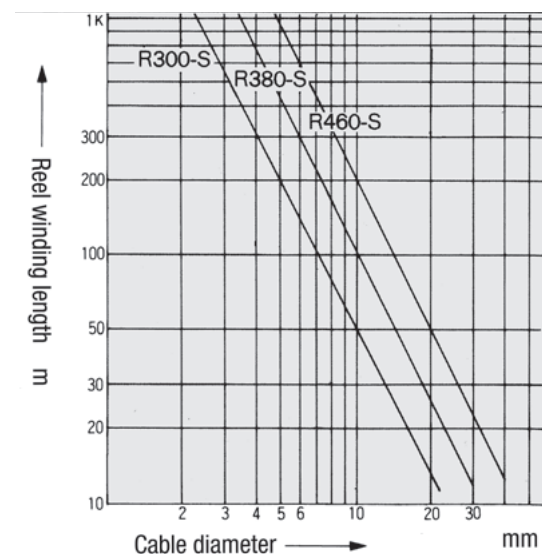

<Wind length conversion formula>

$$R300-S \text{ (S, L, CN)} \quad L = \frac{8448}{D^2} \times 0.6 \text{ (m)} \quad R460-S \quad L = \frac{33852}{D^2} \times 0.6 \text{ (m)}$$

$$R380-S \quad L = \frac{18207}{D^2} \times 0.6 \text{ (m)} \quad D: \text{cable outer diameter (mm)} \\ L: \text{wind length}$$



- High quality and reliable Canare assemblies are ideal for any interconnection including broadcast, professional A/V, and telecommunication.
- Custom assembly configurations can be special ordered at affordable cost and quick lead-time.



### BNC

Type	Model	Length (m)
<b>BNC (M) – BNC (M) Crimp</b>  BLK BRN RED ORN YEL GRN BLU GRY WHT	D3C005A-S	0.5
	D3C01A-S	1
	D3C02A-S	2
	D3C03A-S	3
	D3C05A-S	5
	D3C10A-S	10
<b>BNC (M) – BNC (M) Crimp</b>  BLK BRN RED ORN YEL GRN BLU GRY WHT	D5C005A-S	0.5
	D5C01A-S	1
	D5C015A-S	1.5
	D5C03A-S	3
	D5C05A-S	5
	D5C10A-S	10
<b>BNC (M) – BNC (M) Crimp</b>  BLK RED YEL GRN BLU GRY WHT	D3FBC005E	0.5
	D3FBC01E	1
	D3FBC015E	1.5
	D3FBC02E	2
	D3FBC03E	3
	D3FBC05E	5
<b>BNC (M) – BNC (M) Crimp</b>  BLK RED YEL GRN BLU GRY WHT	D2.5HDC005E	0.5
	D2.5HDC01E	1
	D2.5HDC015E	1.5
	D2.5HDC02E	2
	D2.5HDC03E	3
	D2.5HDC05E	5
<b>BNC (M) – BNC (M) Crimp</b>  BLK BRN RED ORN YEL GRN BLU PPL GRY WHT	D4.5HDC03E	3
	D4.5HDC05E	5
	D4.5HDC10E	10
	D4.5HDC15E	15
	D4.5HDC20E	20

### BNC-DIN

Type	Model	Length (m)	
<b>BNC (M) – DIN (M) Crimp</b>  BLK RED YEL GRN BLU GRY WHT	D2.5HDC005E-D	0.5	
	D2.5HDC01E-D	1	
	D2.5HDC015E-D	1.5	
	D2.5HDC02E-D	2	
	D2.5HDC03E-D	3	
	D2.5HDC05E-D	5	
	D2.5HDC10E-D	10	
	<b>BNC (M) – DIN (M) Crimp</b>  BLK BRN RED ORN YEL GRN BLU PPL GRY WHT	D4.5HDC03E-D	3
		D4.5HDC05E-D	5
		D4.5HDC10E-D	10
D4.5HDC15E-D		15	
	D4.5HDC20E-D	20	

### BNC-RCA

Type	Model	Length (m)
<b>BNC (M) – RCA (M)</b>  BLK BRN RED ORN YEL GRN BLU GRY WHT	D3C01A-SR	1
	D3C03A-SR	3
	D3C05A-SR	5

### DIN

Type	Model	Length (m)	
<b>DIN (M) – DIN (M) Crimp</b>  BLK RED YEL GRN BLU GRY WHT	DN2.5HDC005	0.5	
	DN2.5HDC01	1	
	DN2.5HDC015	1.5	
	DN2.5HDC02	2	
	DN2.5HDC03	3	
	DN2.5HDC05	5	
	DN2.5HDC10	10	
	<b>BNC (M) – BNC (M) Crimp</b>  BLK BRN RED ORN YEL GRN BLU PPL GRY WHT	DN4.5HDC03	3
		DN4.5HDC05	5
		DN4.5HDC10	10
DN4.5HDC15		15	
	DN4.5HDC20	20	



DN2.5HDC

## RCA (Video)

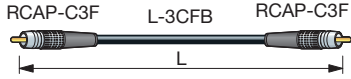
Type	Model	Length (m)
<b>RCA (M) – RCA (M) Solder</b>  BLK BRN RED ORN YEL GRN BLU GRY WHT	DRC01-S	1
	DRC03-S	3
	DRC05-S	5
<b>RCA (M) – RCA (M) Crimp</b>  BLK RED YEL GRN BLU WHT	DRC10-F3	10
	DRC15-F3	15
	DRC20-F3	20
	DRC30-F3	30
	DRC40-F3	40

## Video Patch (W.E. standard)

Type	Model	Length (m)
<b>Video Patch (M) – Video Patch (M)</b>  BLK BRN RED ORN YEL GRN BLU PPL GRY WHT	VPC003-WC	0.3
	VPC005-WC	0.5
	VPC01-WC	1





VPC003-WC

## Triax

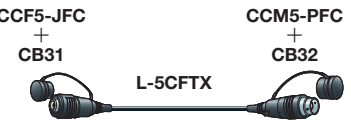
Cables used for connections such as those between broadcast cameras and CCUs.

Type	Model	Length (m)
<b>Triaxial (F) – Triaxial (M)</b> U.S. preferred type  RED	TXC10-K	10
	TXC20-K	20
	TXC30-K	30
	TXC50-K	50
	TXC100-K	100
	TXC150-K	150
	TXC200-K	200
<b>Triaxial (F) – Triaxial (M)</b> EU preferred type  BLK RED GRN	TXC10-F	10
	TXC20-F	20
	TXC30-F	30
	TXC50-F	50
	TXC100-F	100
	TXC150-F	150
	TXC200-F	200

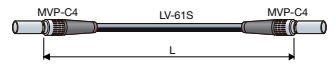
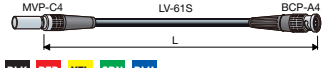
## Mini-WECO Video Patch



Type	Model	Length (m)
 BLK RED YEL GRN BLU	MVPC003	0.3
	MVPC005	0.5
	MVPC01	1
 BLK RED YEL GRN BLU	MVPC02A-BP	2
	MVPC05A-BP	5
 BLK RED YEL GRN BLU	MVPC002-BJ	0.2



MVPC003

## RS422

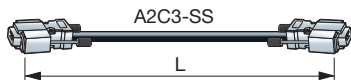
Used for RS422 serial signals that remotely control video cassette recorders.

Type	Model	Length (m)
<b>Dsub9P (M) – Dsub9P (M)</b> 17JE-23090-02 (D8A6)-CG 17JE-23090-02 (D8A6)-CG  BLK Screws : 2.6	DC01-9JE22	1
	DC03-9JE22	3
	DC05-9JE22	5
	DC07-9JE22	7
	DC10-9JE22	10
	DC20-9JE22	20
	DC30-9JE22	30
<b>Dual Bantam – Dual Bantam</b>  For RS422 patchbay. (Manufactured by ADC) GRY	PJ762	0.3
	PJ764	0.6

## DMX

Used for controlling stage and studio lighting equipment. (DMX-512 standard compliance)

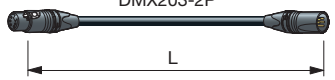
Type	Model	Length (m)
<b>NC5 (F) – NC5 (M)</b>  BLK GRY WHT	DMC01-B	1
	DMC03-B	3
	DMC05-B	5
	DMC10-B	10
	DMC20-B	20
	DMC30-B	30
	DMC50-B	50
	DMC100-B	100

### ■ Cat6 (Standard STP) NEW

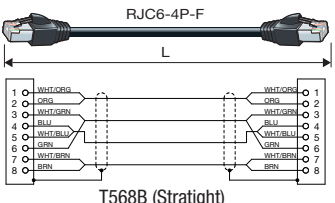
Type	Model	Length (m)
<b>RJ45 - RJ45</b>  	NC6F-01	1
	NC6F-015	1.5
	NC6F-02	2
	NC6F-03	3
	NC6F-05	5
	NC6F-07	7
	NC6F-10	10
	NC6F-15	15
	NC6F-20	20
	NC6F-25	25
	NC6F-30	30
	NC6F-35	35
	NC6F-40	40
	NC6F-45	45
	NC6F-50	50
	NC6F-70	70
	NC6F-100	100

### ■ Cat5e (Flexible STP)

Note: Max. length up to 50m.

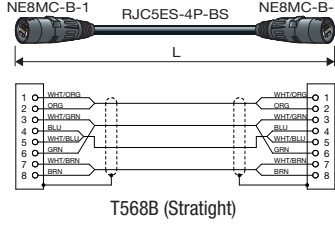
Type	Model	Length (m)
<b>etherCON - etherCON</b>  	ETC003S-B	0.3
	ETC005S-B	0.5
	ETC01S-B	1
	ETC015S-B	1.5
	ETC02S-B	2
	ETC03S-B	3
	ETC05S-B	5
	ETC07S-B	7
	ETC10S-B	10
	ETC15S-B	15
	ETC20S-B	20
	ETC30S-B	30
	ETC50S-B	50

### ■ Cat6 (Standard UTP)

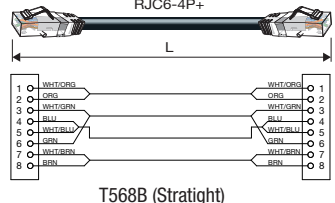
Type	Model	Length (m)
<b>RJ45 - RJ45</b>  	NC6-003	0.3
	NC6-005	0.5
	NC6-01	1
	NC6-015	1.5
	NC6-02	2
	NC6-03	3
	NC6-05	5
	NC6-07	7
	NC6-10	10
	NC6-15	15
	NC6-20	20
	NC6-25	25
	NC6-30	30
	NC6-35	35
	NC6-40	40
	NC6-45	45
	NC6-50	50

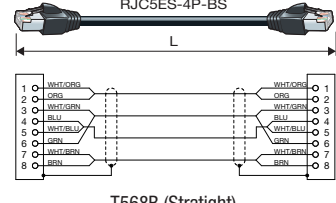
Type	Model	Length (m)
<b>RJ-45 - RJ45</b>  	ETC003S-M	0.3
	ETC005S-M	0.5
	ETC01S-M	1
	ETC015S-M	1.5
	ETC02S-M	2
	ETC03S-M	3
	ETC05S-M	5
	ETC07S-M	7
	ETC10S-M	10
	ETC15S-M	15
	ETC20S-M	20
	ETC30S-M	30
	ETC50S-M	50

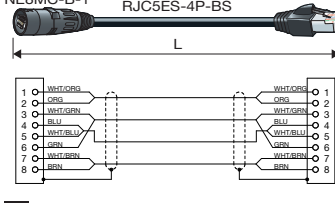
Type	Model	Length (m)
<b>etherCON - RJ45</b>  	ETC02S-BM	2
	ETC05S-BM	5

### ■ Cat5e (Standard UTP)

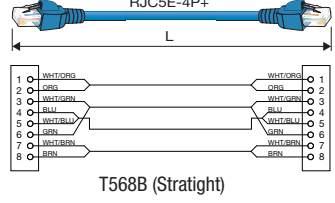
Type	Model	Length (m)
<b>RJ45 - RJ45</b>  	NC5E-003	0.3
	NC5E-005	0.5
	NC5E-01	1
	NC5E-015	1.5
	NC5E-02	2
	NC5E-03	3
	NC5E-05	5
	NC5E-07	7
	NC5E-10	10
	NC5E-15	15
	NC5E-20	20
	NC5E-25	25
	NC5E-30	30
	NC5E-35	35
	NC5E-40	40
	NC5E-45	45
	NC5E-50	50

### ■ Cat5e (Rugged UTP)

Easy routing

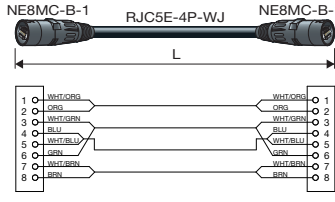
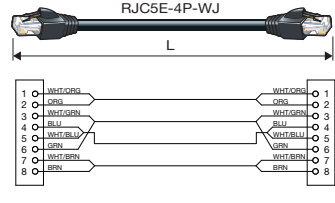
Type	Model	Length (m)
<b>etherCON - etherCON</b>  	ETC10L-B	10
	ETC30L-B	30
	ETC50L-B	50
	ETC70L-B	70
	ETC100L-B	100
<b>RJ-45 - RJ45</b>  	ETC10L-M	10
	ETC30L-M	30
	ETC50L-M	50
	ETC70L-M	70
	ETC100L-M	100

**XLR3**

Type	Model	Length (m)	
<b>XLR3 (F) – XLR3 (M)</b>  XLR3-11C L-4E6S XLR3-12C  BLK BRN RED ORN YEL GRN BLU PPL GRY WHT	EC003	0.3	
	EC005	0.5	
	EC01	1	
	EC015	1.5	
	EC02	2	
	EC03	3	
	EC05	5	
	EC07	7	
	EC10	10	
	EC15	15	
	EC20	20	
	<b>XLR3 (F) – XLR3 (F)</b>  XLR3-11C L-4E6S XLR3-11C  BLK BRN RED ORN YEL GRN BLU PPL GRY WHT	EC003-X11	0.3
		EC005-X11	0.5
		EC01-X11	1
		EC015-X11	1.5
EC02-X11		2	
EC03-X11		3	
EC05-X11		5	
EC10-X11		10	
<b>XLR3 (M) – XLR3 (M)</b>  XLR3-12C L-4E6S XLR3-12C  BLK BRN RED ORN YEL GRN BLU PPL GRY WHT		EC003-X22	0.3
		EC005-X22	0.5
	EC01-X22	1	
	EC015-X22	1.5	
	EC02-X22	2	
	EC03-X22	3	
	EC05-X22	5	
	EC10-X22	10	
	<b>NC3 (F) – NC3 (M)</b>  NC3FXX-B L-4E6S NC3MXX-B  BLK BRN RED ORN YEL GRN BLU PPL GRY WHT	EC003-B	0.3
		EC005-B	0.5
EC01-B		1	
EC015-B		1.5	
EC02-B		2	
EC03-B		3	
EC05-B		5	
EC07-B		7	
EC10-B		10	
EC15-B		15	
EC20-B		20	
<b>NC3 (F) – NC3 (F)</b>  NC3FXX-B L-4E6S NC3FXX-B  BLK BRN RED ORN YEL GRN BLU PPL GRY WHT		EC003-B11	0.3
		EC005-B11	0.5
		EC01-B11	1
		EC015-B11	1.5
	EC02-B11	2	
	EC03-B11	3	
	EC05-B11	5	
	EC10-B11	10	
	<b>NC3 (M) – NC3 (M)</b>  NC3MXX-B L-4E6S NC3MXX-B  BLK BRN RED ORN YEL GRN BLU PPL GRY WHT	EC003-B22	0.3
		EC005-B22	0.5
EC01-B22		1	
EC015-B22		1.5	
EC02-B22		2	
EC03-B22		3	
EC05-B22		5	
EC10-B22		10	

**Phone**

Type	Model	Length (m)	
<b>Mono Phone (M) - Mono Phone (M)</b>  F-15 GS-6 F-15  BLK RED ORN YEL GRN BLU	LC018	1.8	
	LC03	3	
	LC05	5	
	<b>XLR3 (F) - Mono Phone (M)</b>  XLR3-11C L-4E6S F-15  BLK BRN RED ORN YEL GRN BLU PPL GRY WHT	PC03	3
		PC05	5
PC07		7	
PC10		10	
<b>NC3 (F) - Mono Phone (M)</b>  NC3FXX-B L-4E6S F-15  BLK BRN RED ORN YEL GRN BLU PPL GRY WHT	PC03-B	3	
	PC05-B	5	
	PC07-B	7	
	PC10-B	10	
<b>Stereo Phone (M) - Stereo Phone (M)</b>  F-16 L-4E6S F-16  BLK BRN RED ORN YEL GRN BLU PPL GRY WHT	SPC01	1	
	SPC03	3	
	SPC05	5	
	SPC07	7	
	SPC10	10	
	<b>NC3 (F) - Stereo Phone (M)</b>  NC3FXX-B L-4E6S F-16  BLK BRN RED ORN YEL GRN BLU PPL GRY WHT	SPC02-B1	2
		SPC05-B1	5
		<b>NC3 (M) - Stereo Phone (M)</b>  NC3MXX-B L-4E6S F-16  BLK BRN RED ORN YEL GRN BLU PPL GRY WHT	SPC02-B2
	SPC05-B2		5

Fiber-Optic Systems

Connectors

Cables



Panels & Patchbays

Multichannel Systems



Cable Assemblies

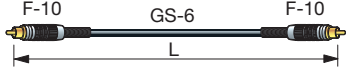
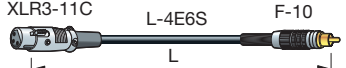
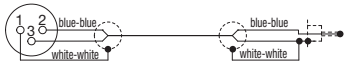
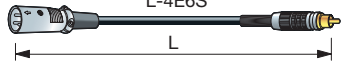
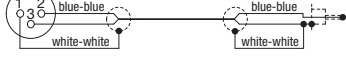

### RCA (Audio)

Type	Model	Length (m)
<b>RCA (M) – RCA (M)</b> 	RC018	1.8
	RC03	3
	RC05	5
<b>XLR3 (F) – RCA (M)</b>  	RC02-X1	2
	RC05-X1	5
<b>XLR3 (M) – RCA (M)</b>  	RC02-X2	2
	RC05-X2	5
<b>Mono Phone (M) - RCA (M)</b> 	QC018	1.8
	QC03	3
	QC05	5

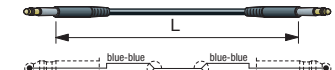
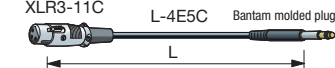
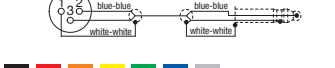
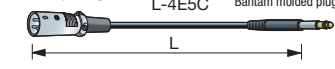
### Audio Patch (Bantam)



Type	Model	Length (m)
<b>Bantam (M) – Bantam (M)</b> 	BC003M	0.3
	BC006M	0.6
	BC009M	0.9
<b>XLR3 (F) - Bantam (M)</b>  	BC02M-X1	2
	BC02M-X2	2
<b>XLR3 (M) – Bantam (M)</b>  	BC02M-X1	2
	BC02M-X2	2



BC003M

### Speaker

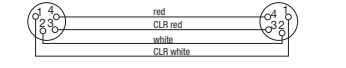

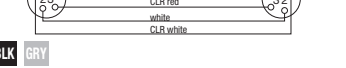
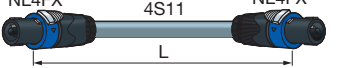
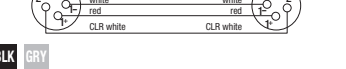



Types available for either XLR or Neutrik "Speakon" connectors.

Type	Model	Length (m)
<b>XLR4 (F) – XLR4 (M)</b>  	SC003	0.3
	SC005	0.5
	SC01	1
	SC05	5
	SC10	10
	SC15	15
<b>XLR4 (F) – XLR4 (M)</b>  	SC05-S8	5
	SC10-S8	10
	SC15-S8	15
<b>NL4 – NL4</b>  	SC05-NL	5
	SC10-NL	10
	SC15-NL	15
	SC20-NL	20
	SC30-NL	30

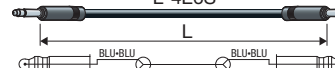

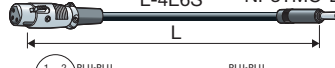
SC05-NL

### Audio Patch (Skini/Maxi)

Type	Model	Length (m)
<b>Skini/Maxi (M) – Skini/Maxi (M)</b>  	TC003B	0.3
	TC005B	0.5
	TC01B	1
<b>XLR3 (F) – Skini/Maxi (M)</b>  	TC02B-X1	2
	TC05B-X1	5
<b>XLR3 (M) – Skini/Maxi (M)</b>  	TC02B-X2	2
	TC05B-X2	5



TC003B

### AES/EBU Digital Audio

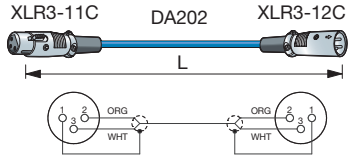
Type	Model	Length (m)
<b>XLR3 (F) – XLR3 (M)</b> 	DAC03	3
	DAC05	5
	DAC10	10
	DAC20	20
	DAC30	30

### AES/EBU Digital Audio (Multi)

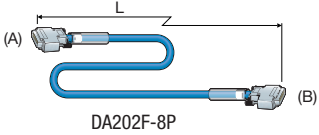
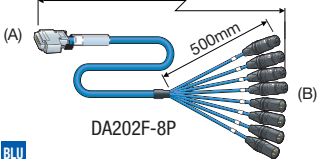
Type	Model	Length (m)
<b>Dsub25P (M) – Dsub25P (M)</b> 	8DAC02-xx	2
	8DAC03-xx	3
	8DAC05-xx	5
	8DAC07-xx	7
	8DAC10-xx	10
	8DAC30-xx	30
<b>Dsub25P (M) - NC3 (F/M)</b> 	8DACS02-xB12	2
	8DACS03-xB12	3
	8DACS05-xB12	5
	8DACS07-xB12	7
	8DACS10-xB12	10
	8DACS30-xB12	30

\* Please use following information to fill in the 'x' in the model above.

#### <Ordering Information>

Model	Brands (ref.)	A-side		B-side	
		Screws	Wiring	Screws	Wiring
8DAC**-DD	Digidesign	4-40	Individual-A	4-40	Individual-B
8DAC**-TT	TEAC	M2.6	Individual-A	M2.6	Individual-B
8DAC**-YY	YAMAHA	M2.6	Common-A	M2.6	Common-B
8DAC**-DY	Digidesign - TEAC	4-40	Individual-A	M2.6	Individual-B
8DAC**-DY	Digidesign - YAMAHA	4-40	Individual-A	M2.6	Common-B
8DAC**-TY	TEAC - YAMAHA	M2.6	Individual-A	M2.6	Common-B
8DACS**-DB12	Digidesign	4-40	Individual-A	N/A	2: Hot 3: Cold
8DACS**-TB12	TEAC	M2.6	Individual-A	N/A	1: Shield
8DACS**-YB12	YAMAHA	M2.6	Common-A	N/A	

#### <Wiring>

Individual-A

Ch. No.	Color Coding	HOT	COLD	SHIELD	N.C.
1	BLU/BRN	24	12	25	13
2	BLU/RED	10	23	11	
3	BLU/ORG	21	9	22	
4	BLU/YEL	7	20	8	
5	BLU/GRN	18	6	19	
6	BLU/-	4	17	5	
7	BLU/PPL	15	3	16	
8	BLU/GRY	1	14	2	

Individual-B

Ch. No.	Color Coding	HOT	COLD	SHIELD	N.C.
1	BLU/BRN	18	6	19	13
2	BLU/RED	4	17	5	
3	BLU/ORG	15	3	16	
4	BLU/YEL	1	14	2	
5	BLU/GRN	24	12	25	
6	BLU/-	10	23	11	
7	BLU/PPL	21	9	22	
8	BLU/GRY	7	20	8	

Common-A

Ch. No.	Color Coding	HOT	COLD	SHIELD	N.C.
1	BLU/BRN	1	14	10	9 11
2	BLU/RED	2	15	12	
3	BLU/ORG	3	16	13	
4	BLU/YEL	4	17	22	
5	BLU/GRN	5	18	23	
6	BLU/-	6	19	24	
7	BLU/PPL	7	20	25	
8	BLU/GRY	8	21		

Common-B

Ch. No.	Color Coding	HOT	COLD	SHIELD	N.C.
1	BLU/BRN	5	18	10	9 11
2	BLU/RED	6	19	12	
3	BLU/ORG	7	20	13	
4	BLU/YEL	8	21	22	
5	BLU/GRN	1	14	23	
6	BLU/-	2	15	24	
7	BLU/PPL	3	16	25	
8	BLU/GRY	4	17		

### Analog Audio (Multi)

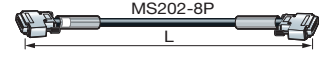
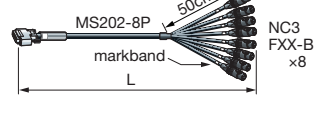
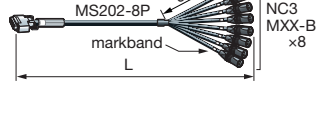
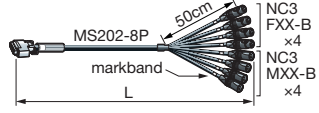
Type	Model	Length (m)
<b>Dsub25P (M) - Dsub25P (M)</b> 	8MC02-x	2
	8MC03-x	3
	8MC05-x	5
	8MC07-x	7
	8MC10-x	10
	8MC30-x	30
<b>Dsub25P (M) - NC3 (F)</b> 	8MCS02-xB1	2
	8MCS03-xB1	3
	8MCS05-xB1	5
	8MCS07-xB1	7
	8MCS10-xB1	10
	8MCS30-xB1	30
<b>Dsub25P (M) - NC3 (M)</b> 	8MCS02-xB2	2
	8MCS03-xB2	3
	8MCS05-xB2	5
	8MCS07-xB2	7
	8MCS10-xB2	10
	8MCS30-xB2	30
<b>Dsub25P (M) - NC3 (F/M)</b> 	8MCS02-CB12	2
	8MCS03-CB12	3
	8MCS05-CB12	5
	8MCS07-CB12	7
	8MCS10-CB12	10
	8MCS30-CB12	30

\* Please choose between A: M2.6 and C: #4-40, and fill in the 'x' in the model with A or C. e.g. 8MC02-A, 8MCS02-CB1

#### <Wiring for 8MC/8MCS>

Ch. No.	Color Coding	Dsub25P				NC3		
		HOT	COLD	SHIELD	N.C.	HOT	COLD	SHIELD
1	BLK/BRN	24	12	25	13	2	3	1
2	BLK/RED	10	23	11		2	3	1
3	BLK/ORG	21	9	22		2	3	1
4	BLK/YEL	7	20	8		2	3	1
5	BLK/GRN	18	6	19		2	3	1
6	BLK/BLU	4	17	5		2	3	1
7	BLK/PPL	15	3	16		2	3	1
8	BLK/GRY	1	14	2		2	3	1

### High Speed HDMI Cable with Ethernet

Type	Model	Length (m)	O.D. (mm)	
	HDM006E	0.6	6.0	
	HDM01E	1		
	HDM015E	1.5		
	HDM02E	2		
	HDM03E	3		
	HDM05E	5		7.0
<p>comes in a blister package</p> <p>MOQ: 16 pcs (3m or less) 12 pcs (5m)</p>	HDM009ED	0.9	6.0	
	HDM015ED	1.5		
	HDM02ED	2		
	HDM03ED	3		
	HDM05ED	5		7.0



### HDMI Extender

Extend uncompressed HDMI signal up to 100 meters over a Cat6 STP cable.

Model	Description
HDE100CP-EX	Package includes TX unit, RX unit, IR cables, AC/DC adapter, and wall mount tabs

#### Key Features and Benefits

- 100m@1080p, 70m@4K with Cat6 STP 24AWG
- Power over Ethernet (PoE)
- Bi-directional RS-232 and wideband IR extension.
- CEC/HDCP passthrough

**Note:** Max. lengths may vary depending on cables.  
HEC and ARC are not supported.

#### <Connection Example>

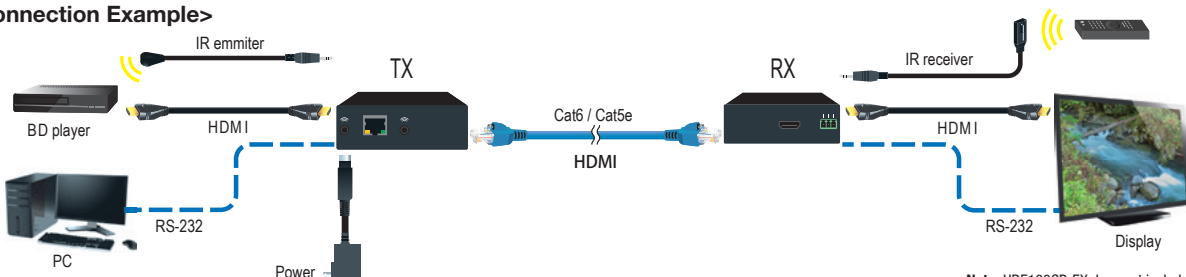

**Note:** HDE100CP-EX does not include Ethernet/HDMI/RS232 cables.

### Active HDMI Cable

HDMI cable built-in equalizer.

Type	Model	Length (m)	O.D. (mm)
	HDM07E-EQ	7	6.0
	HDM10E-EQ	10	7.0
	HDM15E-EQ	15	8.0
<p>HDMI Ethernet Channel not supported</p>	HDM20-EQ	20	9.0

**Note:** Active HDMI cables are directional. Please pay attention to the plug shapes.

### High Speed HDMI Cable

Type	Model	Length (m)	O.D. (mm)
<p>HDMI Ethernet Channel not supported</p>	HDM006	0.6	5.5
	HDM01	1	
	HDM015	1.5	
	HDM02	2	
	HDM03	3	
	HDM05	5	

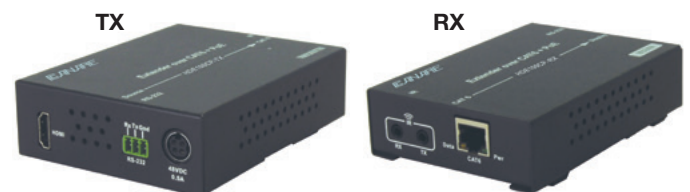

#### HDE100CP-EX

TX: 115 x 32 x 91 mm, 230g  
RX: 115 x 29 x 81 mm, 170g

### DVI-D Dual Link

VESA-DDC Plug and Play compliant

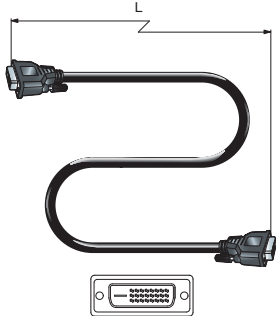
Type	Model	Length (m)
 <p>BLK Screws: #4-40 UNC inch thread</p>	DVID01	1
	DVID015	1.5
	DVID02	2
	DVID03	3
	DVID05	5

### DVI-HDMI NEW

DVI-D Single Link to HDMI

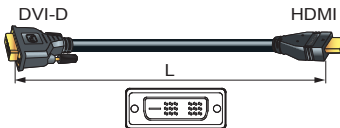
Type	Model	Length (m)
 <p>BLK Screws: #4-40 UNC inch thread</p>	DVI01-HDM	1
	DVI015-HDM	1.5
	DVI02-HDM	2
	DVI03-HDM	3
	DVI05-HDM	5

Note: DVI cannot carry audio signal.

### VGA

VESA-DDC Plug and Play compliant. 5VDC-1.7CF series are enhanced by low-loss coax unit.

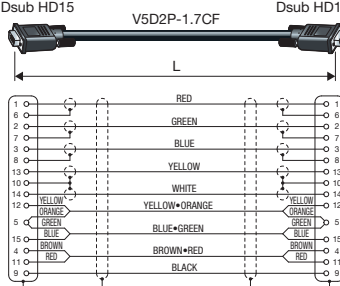
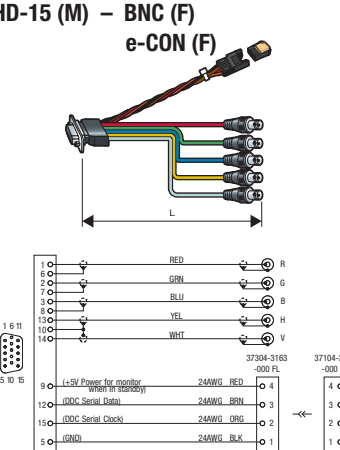
Type	Model	Length (m)
 <p>BLK Screws: #4-40UNC inch thread</p>	5VDC015-1.7CF	1.5
	5VDC02-1.7CF	2
	5VDC03-1.7CF	3
	5VDC05-1.7CF	5
	5VDC10-1.7CF	10
	5VDC15-1.7CF	15
	5VDC20-1.7CF	20
 <p>e-CON male plug and lock nuts included</p>	HDR15F-EJ1.5CA	0.13

• V5D2P-1.7CF is not for sale.

### VGA

Not compatible with VESA-DDC Plug and Play.

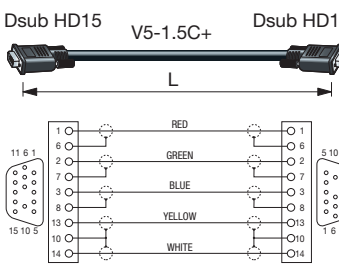
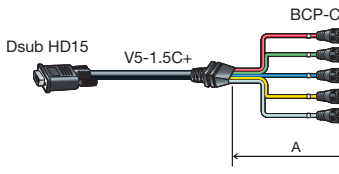
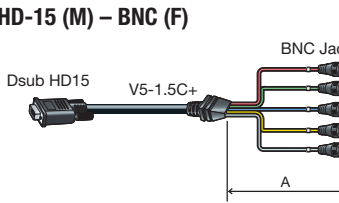
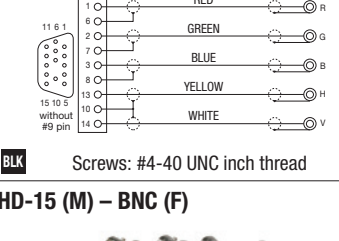
Type	Model	Length (m)
 <p>BLK Screws: #4-40 UNC inch thread</p>	5VDC015A-1.5C	1.5
	5VDC02A-1.5C	2
	5VDC03A-1.5C	3
	5VDC05A-1.5C	5
	5VDC10A-1.5C	10
 <p>BLK Screws: #4-40 UNC inch thread</p>	5VDS015A-1.5C	1.5
	5VDS02A-1.5C	2
	5VDS03A-1.5C	3
	5VDS05A-1.5C	5
	5VDS10A-1.5C	10
 <p>BLK Screws: #4-40 UNC inch thread</p>	5VDS003A-J1.5C	0.3
	5VDS015A-J1.5C	1.5
	5VDS02A-J1.5C	2
	5VDS03A-J1.5C	3
	5VDS05A-J1.5C	5
 <p>BLK Screws: #4-40 UNC inch thread</p>	HDR15F-J1.5CA	0.13



5VDS02A-1.5C



### VGA with Audio

VESA-DDC Plug and Play compliant

Type	Model	Length (m)
HD-15 (M) 3.5mm TRS	A1VGA005	0.5
HD-15 (M) 3.5mm TRS	A1VGA0075	0.75
	A1VGA01	1
	A1VGA015	1.5
	A1VGA02	2
	A1VGA03	3
	A1VGA05	5
	A1VGA10	10

A: 20cm (A1VGA005)  
60cm (others)

BLK Screws: #4-40 UNC inch thread

### 3 RCA Video & Audio NEW

Type	Model	Length (m)
RCA - RCA 	3RCS003	0.3
	3RCS005	0.5
	3RCS01	1
	3RCS015	1.5
	3RCS02	2
	3RCS03	3
	3RCS05	5
	3RCS10	10
	3RCS15	15
	3RCS20	20
	3RCS30	30

BLK

### 2 RCA Stereo Audio NEW

Type	Model	Length (m)
RCA - RCA 	2RCS003	0.3
	2RCS005	0.5
	2RCS01	1
	2RCS015	1.5
	2RCS02	2
	2RCS03	3
	2RCS05	5
	2RCS10	10
	2RCS15	15
	2RCS20	20
	2RCS30	30

BLK

👑 : Bestselling products

0	06-1001-015	74	2FG5Z3S**-S	24	6PSC**-	13	BCJ-JRUD	33		
	06-1001-016	74	2FG6Z3S**-S	24	820AQ	73	BCJ-JRUDB	33		
	06-1001-017	74	2FS**-S	24	8B1N2	77	BCJ-MVP	68		
	06-1877-04	74	2FSZ3S**-S	24	8B2N1	77	BCJ-R	33		
1	10CFTX-SC	61	2PSC	13	8C**-E3	76	BCJ-R/1	33		
	10PSC-JP	13	2RCS**	88	8C**-M2	76	BCJ-RCAP	36		
	125	74	👑2S11F	57	8DAC**-xx	85	BCJ-RPC	35		
	12B1N2	77	2S11FG	57	8DACS**-xB12	85	BCJ-RPC/1	35		
	12B2N1	77	2S14F	57	8FS**-S	24	BCJ-RPLH	35		
	12C**-E3	76	2S14FG	57	8J12N1	77	BCJ-RPLV	35		
	12C**-M2	76	👑2S7F	57	8J12N12	77	BCJ-RU	33		
	12FS**-S	24	2S7FG	57	8J12N2	77	BCJ-RUC1	33		
	12J12N1	77	👑2S9F	57	8MC**-x	85	BCJ-RUD	33		
	12J12N12	77	2S9FG	57	8MCS**-CB12	85	BCJ-RUDB	33		
	12J12N2	77	2U-AS*	72	8MCS**-xB1	85	BCJ-TRC-XP3F	45		
	12R**-E3	76	2U-AS*D	72	8MCS**-xB2	85	BCJ-TRC-XP3M	45		
	12S1N2	77	3	320A	73	8R**-E3	76	BCJ-VWP	68	
	12S2N1	77		32-12A/620A/EIA	73	8S1N2	77	👑BCJ-XJ-A10TRC	45	
	14347 CLEANER	20		32B12MF11	77	8S2N1	77	👑BCJ-XJ-TRC	45	
	161U-B1	71		32B12MS	77	9	90-602	74	👑BCJ-XP-TRC	45
	161U-B2	71		32B12MSW	77		90-608	74	BCP-A25	30
	161U-JRU	71		32B12MWF11	77		90-T	74	BCP-A25F	30
	161U-JRUDB	71		32C**-M2	76	A	A1VGA**	88	BCP-A3	30
	161UPSC**-	13		32C005-M2MS22	76		A2C3	58	BCP-A31	30
	161U-X12F	71	👑	32MD-ST	67		A2C3-SS	58	BCP-A32	30
	161U-X1F	71		32MD-ST-*U	67		A2V1	63	BCP-A3F	30
	161U-X2F	71		32MD-STs	67		A2V1B	63	👑BCP-A4	30
	162U-JRU	71		32MD-STs-*U	67		A2V2B	63	BCP-A42	30
	162U-X21	71		32S1MS2	77		A2V2-L	63	BCP-A4F	30
	162U-X22	71		32S2MS2	77		A3V2-FB	63	BCP-A5	30
	16B1F2	77		32WB-*	74		ABJ-DC	73	BCP-A52	30
	16B2F1	77		32XP-*	74		AN3420-*	76	BCP-A55	30
	16C**-E3	76		3U-AS*	72		ASPT-1	19	BCP-A5F	30
	16C**-M2	76		3U-AS*D	72	B	B11014E	30, 31, 38	BCP-A77	30
	16FS**-S	24	NEW	3RCS**	88		B11015E	30, 31, 38	👑BCP-B25HD	30
	16J12F1	77	4	48-12A/820AQ/EIA	73		B11016E	30, 31, 38	BCP-B25HW	30
	16J12F12	77		481U-820AQ	73		B11020D	30, 31, 38	BCP-B26	30
	16J12F2	77		481U-WB*	74		B75004A	30, 31, 38, 39	BCP-B28	30
	16R**-E3	76		48WB-*	74		BC**M	84	BCP-B31F	30
	16S1F2	77		48XP-*	74		BC**M-X1	84	👑BCP-B3F	30
	16S2F1	77		4FS**-S	24		BC**M-X2	84	👑BCP-B45HW	30
	1U-AS*	72	NEW	4FS**T-LS	23		BCA-RL	27	👑BCP-B4F	30
	1U-AS*D	72	NEW	4FS**T-SS	23		BCA-RS	27	BCP-B51F	30
2	20DV	66	NEW	4FS**T-ST	23		BCA-TL	27	👑BCP-B53	30
	20DV-2U	66		👑4S10F	56		BCA-TS	27	BCP-B56	30
	20DVS	66		4S10FG	56		BCJ-A10TRC-XP3F	45	👑BCP-B5F	30
	20DVS-2U	66		👑4S11	56		BCJ-BPC2P	34	BCP-C1	30
	24B12MS	77		4S11G	56		BCJ-BPLH2PA	34	BCP-C5HD	30
	24B12MSW	77		👑4S12F	56		BCJ-BPLH3PA	34	BCP-C6HD	30
	24C**-E3	76		4S12FG	56		BCJ-BPLHA	34	BCP-C71A	30
	24C**-M2	76		4S14F	56		BCJ-C4	32	BCP-C7FA	30
	24C005-E3MS22	76		4S18F	56		BCJ-DC	36	👑BCP-C7HD	30
	👑24DV	66		👑4S6	56		BCJ-DC-CH	36	BCP-DCJ	28
	👑24DV-2U	66		4S6G	56		BCJ-DCJ	28	BCP-H31F	32
	24DVS	66		👑4S8	56		BCJ-FC1	33	BCP-H3B	32
	24DVS-2U	66		4S8G	56		BCJ-FC1-7/16	33	BCP-H45HW	32
	24FS**-S	24	5	525	74		BCJ-FPC	34	BCP-H5/1	32
	24R30-E3	76		5VDC**-1.7CF	87		👑BCJ-FPC02	34	BCP-H51F	32
	24S1MS2	77		5VDC**A-1.5C	87		BCJ-FPLHA	34	BCP-H5B	32
	24S2MS2	77		5VDS**A-1.5C	87		👑BCJ-FPLV01	34	BCP-LC3	31
	👑26DV	66		5VDS**A-J1.5C	87		BCJ-FPLVA	34	BCP-LC3F	31
	26DV-2U	66	6	6000AQ	73		BCJ-FPLV-L	34	BCP-LC5	31
	26DVS	66		612A/320A/EIA	73		BCJ-J	32	BCP-LC5F	31
	26DVS-2U	66		620A	73		👑BCJ-JR	33	BCP-RCAJ	36
	26WB-*	74		6FS**-S	24		👑BCJ-JRU	33	NEW BCP-TB	32

<b>NEW</b> BCP-TB-CH	32	BP-C5	40	👑 DA206	55	<b>NEW</b> FCBA4-FM5W2	14
BCP-VA3	28	BP-C51	40	DAC**	85	<b>NEW</b> FCBA4-FM5W2-PV	14
BCP-VA5	28	BP-C5FA	40	DC**-9JE22	81	FCBA-FF3W1	15
BET-12	42	BP-D	71	DCF01	29	FCBA-FF3W1-PV	15
BET-DIN	42	BP-DXF	71	DCF02	37	FCBA-FM3W2	15
BET-MBNC	42	BP-LC31	40	DCJ-C25HW-ML	29	FCBA-FM3W2-PV	15
BJ-J	40	BP-LC51	40	DCJ-FEM	28	FCC**-7N	17
BJ-JR	40	BP-XF	71	DCJ-JR	28	FCC**-7T	18
BJ-JRU	40	<b>C</b> CB01	32	DCJ-LR	28	FCC**-9T	18
BJ-JRUD	40	CB02	32	DCJ-LR/1	28	FCC**A-FMRC	19
BN1002B	39	CB03	32	DCM01	29	FCC**A-FRCM	19
BN1003B	39	CB04	32	DCM02	37	FCC**A-WJ	16
BN1004B	39	CB05A	32	DCM03	37	👑 FCC**N	16
BN1005B	39	CB22	37	DCP-C25HD	28	FCE-*	22
BN1012B	30	CB23	37	DCP-C25HW-ML	29	FCS003A-FR	21, 22
BN1016C	40	CB24	32	DCP-C3F	28	FCS003A-MR	21, 22
BN1018A	30	CB25	32	DCP-C4F	28	FCS015A-FR	19
BN1023A	40	CB26	32	DCP-C53	28	FCS015A-MR	19
BN1024A	40	CB31	37	DMC**-B	81	FCT-FC	22
BN1025B	40	CB32	37	DMX203-2P	58	👑 FCT-FCKIT	22
BN1030A	39	CCF4-JK	37	DN2.5HDC**	80	FCT-FCLB	22
BN1041A	39	CCF4-JKR	37	DN4.5HDC**	80	FCWDM16A	12
BN1043A	30	CCF5-JFC	37	DRC**-F3	81	FCWDM8/1A	12
BN1082A	30	CCF5-JFRC	37	DRC**-S	81	FCWDM8/1A-13	12
BN1083A	30	CCF7-JFC	37	DS10-AS1	73	FCWDM8/2A	12
BN1093	38	CCF7-JFRC	37	DS10-AS2	73	FCWDM8/2A-13	12
BN1131	37	CCM4-PK	37	DS10-AS3	73	FCWDM-8B	12
BN1135	37	CCM4-PKR	37	DS10-AS4	72	FCWDM-8B-13	12
BN1139	30	CCM5-PFC	37	<b>NEW</b> DVI**-HDM	87	FDM-*	12
BN1148	28	CCM5-PFRC	37	DVID**	87	FG53C**-S	24
BN1157	28	CCM7-PFC	37	DVJB-S	66	FG63C**-S	24
BN1158	28	CCM7-PFRC	37	DVJB-W	66	FJ-FPC	39
BN7002	40	CLETOP 2.5/2.0	20	<b>E</b> EB-02	75	FJ-JR	39
BN7003A	28, 30, 31, 38, 39	COF-**	22	EB-03	75	FJ-JRU	39
BN7011	30, 38, 39	COPS3-FF*	20	EC**	83	FJ-JRUD	39
BN7014	30, 39	COPS3-FM*	20	EC**-B	83	FJ-JRUDB	39
BN7015A	28, 30, 31, 38, 39	COPS-FF*	20	EC**-B11	83	FK37-21C7/8-R	76, 77
BN7016	30, 31, 38, 39	COPS-FM*	20	EC**-B22	83	FK37-22C7/8-R	76, 77
BN7021A	30, 39	COU-BP*	21	EC**-X11	83	FK37-31S-R	76
BN7022	30	COUS-FF*	21	EC**-X22	83	FK37-32S-R	76
BN7026A	30	COUS-FM*	21	EE3G-100	7	FP-C25HD	39
BN7029C	30, 31, 38	CR100-CN	79	EO-100A-**	8	FP-C3	39
BN7030A	40	CR100-S	79	EO-100B	8	FP-C31	39
BN7045A	30, 39	CR90-BN	79	EO-160	8	FP-C3F	39
BN7046	30, 31, 39	<b>D</b> D/MS3057-20A	76	EO3G-100	7	FP-C4	39
BN7052A	30	D/MS3057-24A	76	EO3G-100A-**	7	FP-C4F	39
BN7074A	30	D/MS3101A32A10P	76, 77	EO3G-200	7	FP-C5	39
BN7079	38	D/MS3101A36-73P	76, 77	EO-500-**	9	FP-C52	39
BN7113	37	D/MS3102A32A10P	76	EO-700	8	FP-C53A	39
BN7114	37	D/MS3102A36-73P	76	EO-700A-**	8	FP-C55A	39
BN7120	37	D/MS3106B32A-10S	76	ETC**L-B	82	FP-C5F	39
BN7121	37	D/MS3106B36-73S	76	ETC**L-M	82	FP-C71A	39
BN7129	30, 38, 39	D2.5HDC**E	80	ETC**S-B	82	FP-C7FA	39
BN7136	28	D2.5HDC**E-D	80	ETC**S-BM	82	FS3C**-S	24
BN7138	28	D3C**A-S	80	ETC**S-M	82	<b>G</b> GS-4	58
BN7143	30	D3C**A-SR	80	<b>F</b> 👑 F-09	38	👑 GS-6	58
BN9078A	29	<b>NEW</b> D3FBC**-E	80	F-10	38	<b>H</b> HDE100CP-EX	86
BN9079B	29	D4.5HDC**E	80	F-11	39	HDM**	86
BN9127A	37	D4.5HDC**E-D	80	F-12	39	HDM**E	86
BN9128B	37	D5C**A-S	80	F-15	39	HDM**ED	86
BN9182A	37	👑 DA202	55	F-16	39	HDM**E-EQ	86
BN9194	37	👑 DA202AT	55	F3-FCC**-7N	17	HDM20-EQ	86
BP-C3	40	👑 DA202F-*P	55	F5-FCC**-7N	17	HDR15F-EJ1.5CA	87
BP-C31	40	DA203-*AL	55	<b>NEW</b> FCBA4-FF5W1	14	HDR15F-J1.5CA	87
BP-C4	40	DA203AL	55	<b>NEW</b> FCBA4-FF5W1-PV	14	<b>I</b> IU-7/16	33

IU-FCF-SET	19
IU-FCM-SET	19
<b>L</b> L-1.5C2VS	61
L-2.5C2V	61
L-2.5CFB	61
<b>W</b> L-2.5CHD	60
L-2.5CHLT	60
L-2B2AL	51
<b>W</b> L-2B2AT	51
L-2E4-*AL	52
L-2E5	51
L-2E5AL	51
<b>W</b> L-2E5AT	51
L-2T2S	51
L-3C2V	61
L-3C2VS	61
L-3C2W	61
<b>W</b> L-3CFB	61
L-3CFW	61
L-3D2V	63
L-3D2W	63
<b>W</b> L-4.5CHD	60
<b>W</b> L-4.5CHWS	60
<b>W</b> L-4CFB	61
L-4CFTX	61
L-4CHD	60
L-4E3-*AT	50
<b>W</b> L-4E3-*P	50
L-4E3-2H	50
L-4E3AT	49
<b>W</b> L-4E4-*AT	50
L-4E4-*P	50
L-4E5	49
<b>W</b> L-4E5AT	49
L-4E5ATG	49
L-4E5C	49
L-4E6	49
<b>W</b> L-4E6AT	49
L-4E6ATG	49
<b>W</b> L-4E6S	49
<b>NEW</b> L-4E6-WBS	49
L-5C2V	61
L-5C2VS	61
L-5C2W	61
<b>W</b> L-5CFB	61
L-5CFTX	61
L-5CFW	60
L-5CHD	60
L-5D2V	63
L-5D2W	63
L-5DFB	63
L-6CHD	60
L-7CFB	61
L-7CFTX	61
<b>W</b> L-7CHD	60
L-8CHD	60
LC**	83
LF-2SM16	16
LF-2SM7N	17
LF-2SM7N-*P	17
<b>NEW</b> LF-2SM7T	18
LF-2SM9	16
<b>W</b> LF-2SM9N	16
<b>NEW</b> LF-2SM9T	18
LF-SM2-*C	23

<b>NEW</b> LF-SM2T-4C	23
<b>W</b> LV-61S	61
LV-77S	61
<b>M</b> M202-*AT	53
MBCP-C25F	31
MBCP-C3F	31
MBCP-C4	31
MBCP-C4F	31
MBCP-C53	31
MBCP-C5F	31
MCF-V5C3	29
MCM-V5C3	29
MDF-V4C25HW	29
MDF-V4JRU	29
MDM-V4C25HW	29
MDVJ-ST5	67
MDVJ-STW	67
MJ2-M32-1U-***	70
MJ2-M32-2U-***	70
M-MA*U02	72
<b>W</b> MR202-*AT	53
MS202	52
MS202-*P	54
MS203	52
MS203-*BS	54
MVJ-DC	67
MVPC**	81
MVPC**A-BP	81
MVPC**B-J	81
MVP-C4	68
<b>N</b> NE5E-**	82
NC6-**	82
<b>NEW</b> NC6F-**	82
NCJ-BCJR	36
NCP-H8HD	36
NDT-DIN	28
NK27-21C3/4-R	76, 77
NK27-21C7/8-R	76
NK27-22C3/4-R	76, 77
NK27-22C7/8-R	76
NK27-31S-R	77
NK27-32S-R	77
NP3TMC-B	73, 84
NP-C**	41
NP-LC**	41
<b>O</b> OE-101B	8
OE-151	8
OE3G-101	7
OE3G-201	7
OE-501	9
OE-701	8
OM6C**	25
OM6S**JR	25
OM6S**PR	25
<b>P</b> PC**	83
PC**B	83
PH50-*	73
PJ743	73
PJ748	73
PJ762	81
PJ764	81
PSM2-**	13
<b>Q</b> QC**	84
<b>R</b> R300	79
R300-BN	79

R300-CN	79
R300-L	79
R300-S	79
R380-S	79
R460-S	79
RC**	84
RC**-X1	84
RC**-X2	84
RCAP-C25F	38
RCAP-C25HD	38
RCAP-C3A	38
RCAP-C3F	38
RCAP-C3GS	38
RCAP-C42	38
RCAP-C4A	38
RCAP-C4F	38
RCAP-C53	38
RCAP-C5A	38
RCAP-C5F	38
RCAP-C77	38
RJ-BCJRU	38
RJ-BCJRUD	38
RJ-BCJRUDB	38
RJC5E-4P+	59
RJC5E-4P-WJ	59
RJC6-4P+	59
<b>NEW</b> RJC6-4P-F	59
RJ-JR	38
RJ-JRU	38
RJ-JRUD	38
RJ-JRUDB	38
RJ-RU	38
RJ-RUD	38
RJ-RUDB	38
RS-422-1U-***	70
RS-422-2U-***	70
<b>S</b> S410-*P	56
SC**	84
SC**-NL	84
SC**-S8	84
SMAJ-C*	41
SMAJ-C*	41
SPC**	83
SPC**-B1	83
SPC**-B2	83
<b>T</b> TB-2A	42
TC**B	84
TC**B-X1	84
TC**B-X2	84
TC-1	42
TC-2	42
TCD-1DB	42
TCD-3151D	42
TCD-316C	42
TCD-31C	42
TCD-35CA	42
TCD-35D	42
TCD-35DF	42
TCD-451CA	42
TCD-4CA	42
TCD-55FA	42
TCD-5CF	42
TCD-5HD	42
TCD-65C	42

TCD-67HD	42
TCD-7CA	42
TCD-96C	42
TCD-D253F	42
TCD-D534F	42
TNP-C*	41
TNP-LC**	41
<b>NEW</b> TRM-100	11
<b>NEW</b> TRM-101	11
TRM-210	10
TRM-210A-***	10
TRM-211	10
TRM-220	11
TRM-220A-***	11
TRM-221	11
TRM-230	11
TRM-231	11
TRM-300A-G**	10
TRM-300-G**	10
TRM-400	11
TRM-401	11
TRM-540	9
TRM-540A-***	9
TRM-541	9
TRP-300-LN13	13
<b>W</b> TS100E	42
TS100U	42
TSC	42
TXC**F	81
TXC**K	81
<b>V</b> V*-1.5C	62
V*-3C	62
V*-3CFB	62
V*-3CFW	62
V*-4CFB	62
V*-5C	62
V*-5CFB	62
V*-5CFW	62
V4-2.5CHW	62
VJ2-M32-4U	70
VJ2-V20-1U-***	70
VJ2-V20-2U-***	70
VJ2-V24-1U-***	70
VJ2-V24-2U-***	70
VJ2-V26-1U-***	70
VJ2-V26-2U-***	70
VJ-DC	66
VPC**-WC	81
VWP-C4A	68
<b>X</b> XJ3F-A10TRC-BCJ	45
XJ3F-P3FA	71
XJ3F-P3MA	71
XJ3F-TRC-BCJ	45
XJ3M-P3FA	71
XJ3M-P3MA	71
XJ3M-TRC-BCJ	45
XLR3-11C	75, 77, 83
XLR3-12C	75, 77, 83
XLR3-31F77	75, 77
XLR3-32F77	75, 77
XLR4-11C	84
XLR4-12C	84



## **GENUINE Canare Products for the Best Quality.**

---

### **Canare Electric Co., Ltd.**

Japan Headquarters (Overseas Department)

4th FL, WN Bldg., 2-4-1 Shin-Yokohama, Kouhoku-ku,  
Yokohama-shi, Kanagawa, 222-0033 Japan

Phone: +81-45-470-5674

Fax: +81-45-470-5676

E-mail: [overseas@canare.co.jp](mailto:overseas@canare.co.jp)

[www.canare.co.jp/en/](http://www.canare.co.jp/en/)

---

