

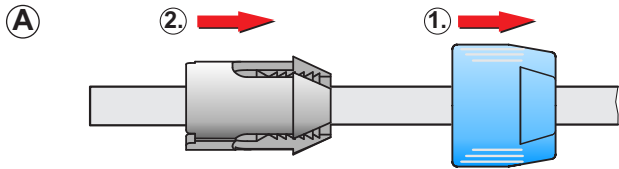

ASSEMBLY INSTRUCTION

RLS4FC | Lockable Loudspeaker Connector



A Put bushing and chuck onto the cable.

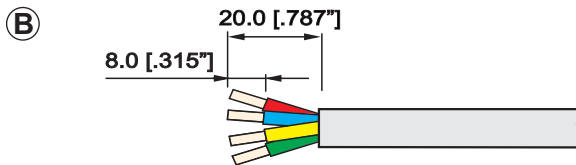

B Prepare cable as shown.

C Insert the wires into the terminals and fasten the clamping device by help of a screw driver (Poqidrive®).

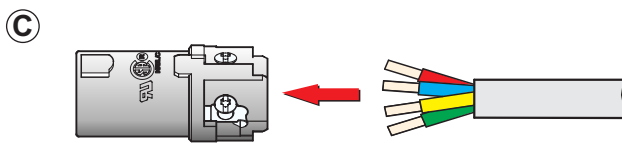

D Push insert and chuck into housing (pay attention to the guiding keyway).

E Fasten bushing by means of a fork wrench 3/4".

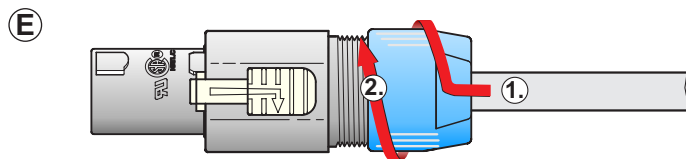
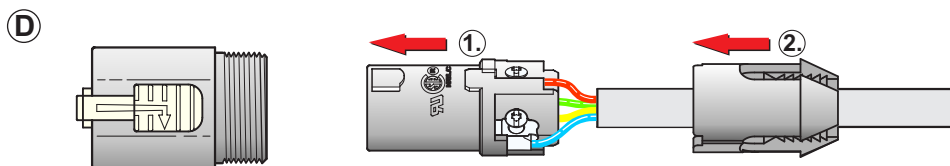
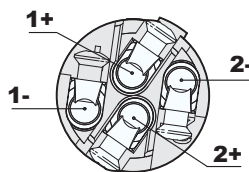

Handling

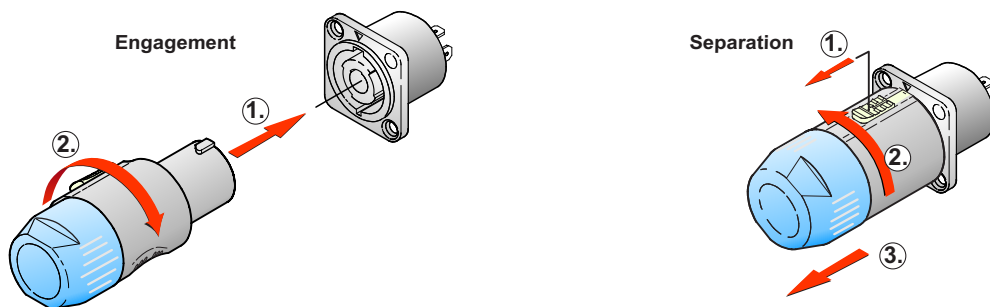

Safety Instruction

 E 135 070	220V ac 13 A with AWG 10 10 A with AWG 12	 C US
NOT FOR USE AS MAINS (A.C.) CONNECTOR <small>"CAUTION: NOT FOR INTERRUPTING CURRENT" "ATTENTION: NE PAS UTILISER POUR COUPER LE COURANT"</small>		

NEUTRIK AG	LI	T: +423 / 237 24 24	F: +423 / 232 53 93	NEUTRIK France	FR	T: +33 1 / 4131 6750	F: +33 1 / 4131 0511
NEUTRIK USA Inc.	USA	T: +1 704 / 972 3050	F: +1 704 / 438 9202	NEUTRIK Tokyo Ltd.	JP	T: +81 3 / 3663 4733	F: +81 3 / 3663 4796
NEUTRIK (UK) Ltd.	UK	T: +44 1983 / 811 441	F: +44 1983 / 811 439	NEUTRIK Hong Kong Ltd.	HK	T: +852 / 2687 6055	F: +852 / 2687 6052
NEUTRIK Vertriebs GmbH	DE/NL/AT/DK	T: +49 8131 / 280 890	F: +49 8131 / 280 830				

Draft. Nr.: BDA 322 / 3102M1971 | Update: 19.09.2011 | Data subject to change without prior notice. ©2011 NEUTRIK®. ALL RIGHTS RESERVED. NEUTRIK® are registered trademark.

www.rean-connectors.com

REAN
REAN a brand of Neutrik AG