

Frontplattenausschnitt (Frontseite)
Panel cut out (front side)

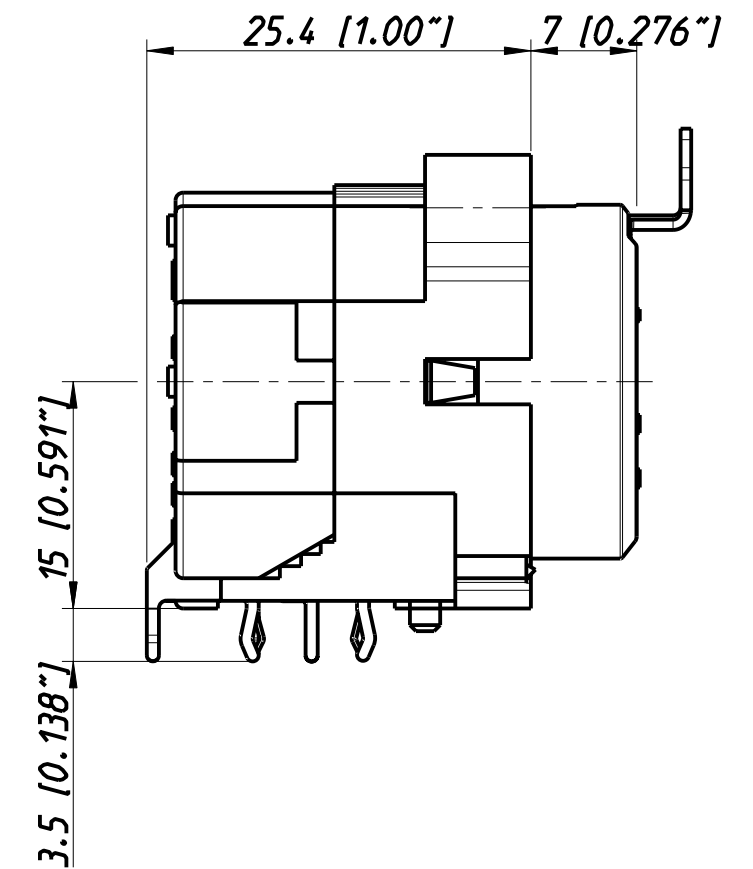

Print-Bohrplan (Bestueckungsseite)
PCB-LAYOUT (component side)

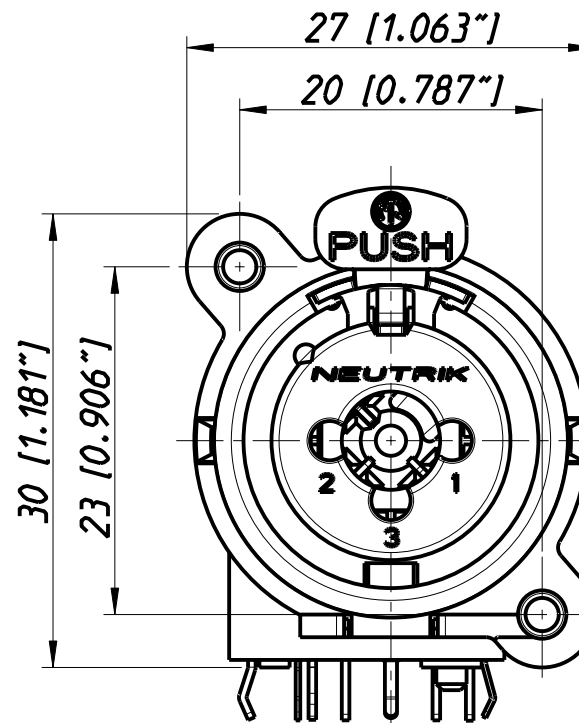
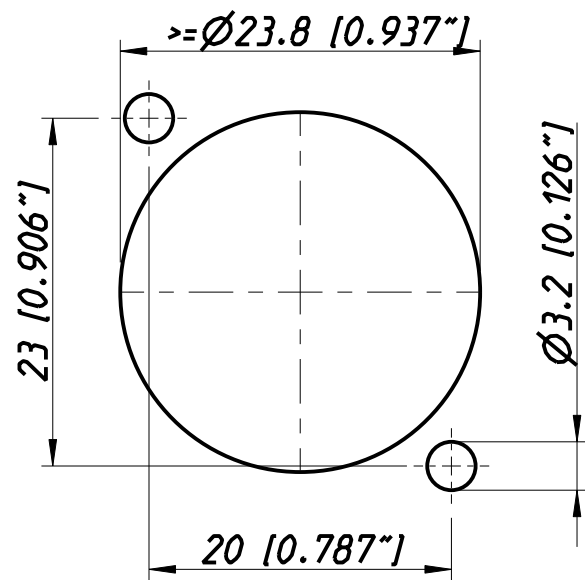
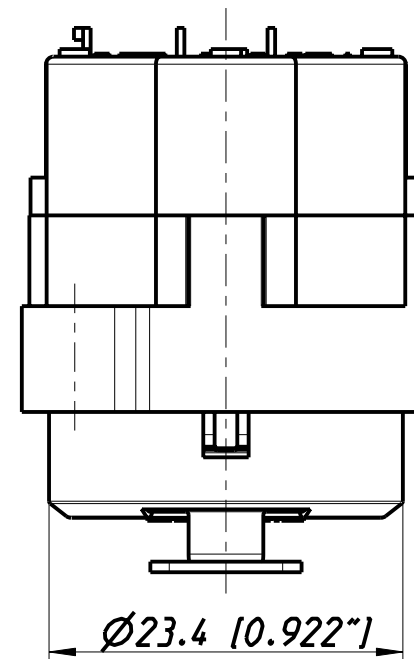
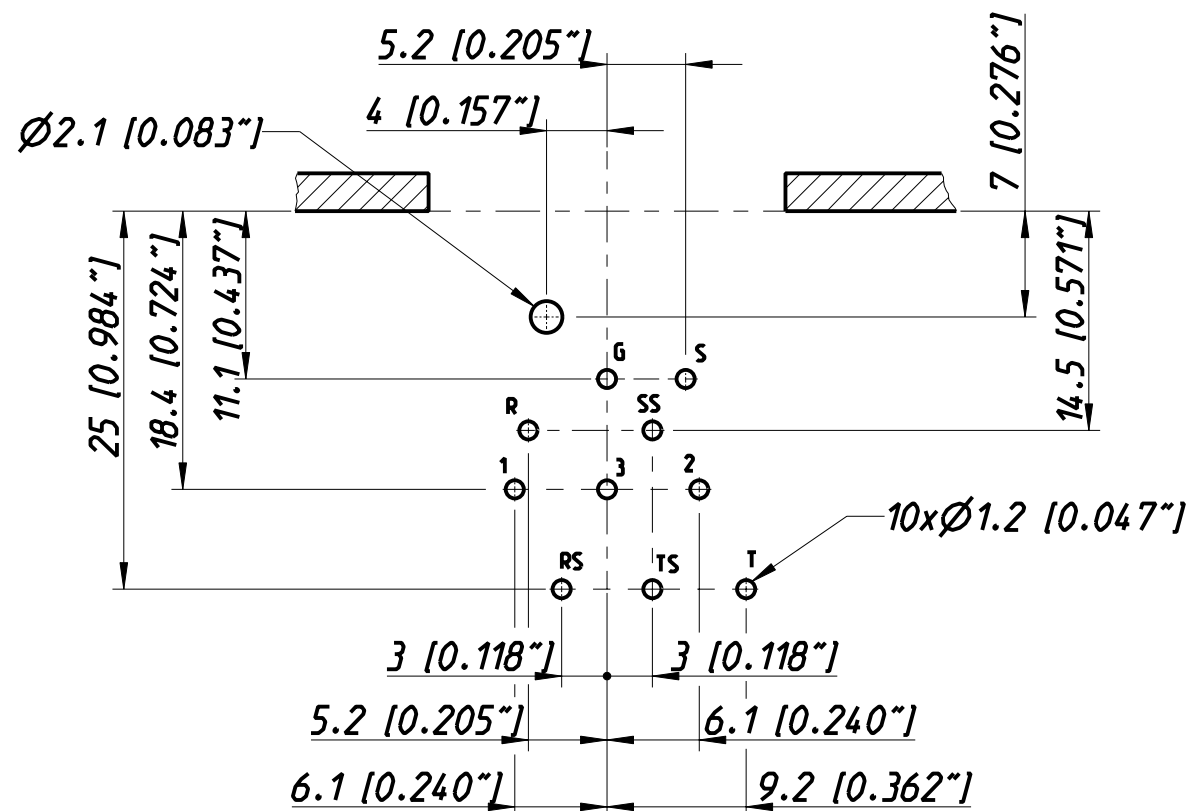

NORMALLING-SCHEMES

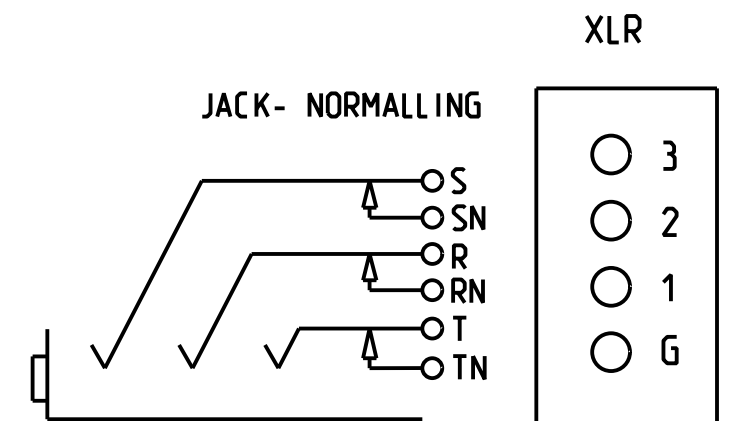

Allgemeintoleranzen ISO 2768-m	Werkstoff KEIN_MAT	Massstab: 2:1 (A3)	Gezeichnet	Datum	Name
			Freigegeben	25.05.98	Dobler
Zeichnung urheberrechtlich geschuetzt (DIN 34) (C)	-	-	Geaenderf	-	-
			Aend.-Nr. 245-2003	07.11.03	Payr
Benennung - NC J9F1-H			Aend.-Index D		Aend.-Index Blatt 1 von 1 Bl.
NEUTRIK AG FL-9494 SCHAAN			Zeichn. Nr. 3102ST1712		